

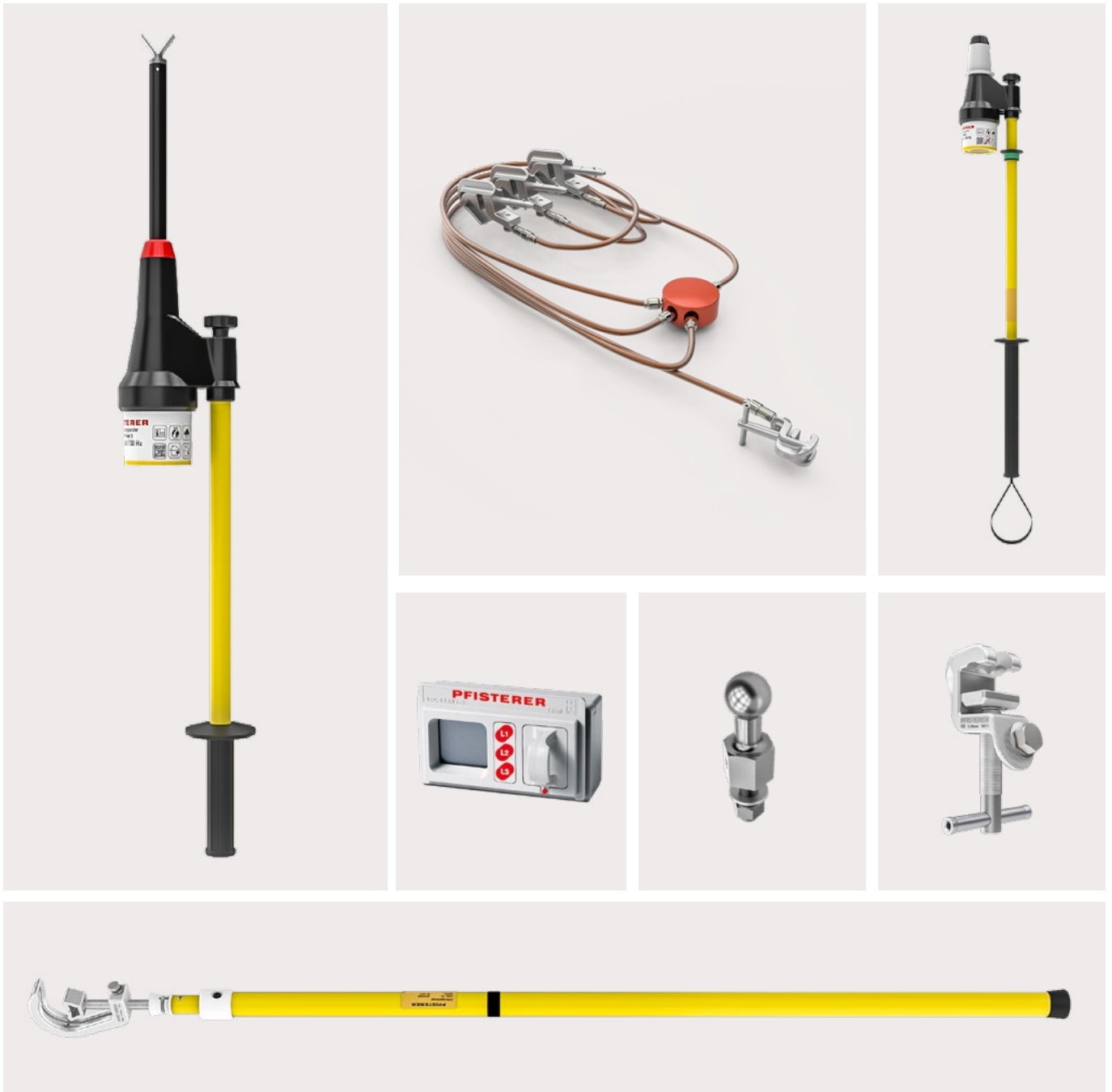

Safety equipment

Utilities





Nowhere is the
reliability of work
equipment more
important.

L1

Setting the standard in safety.

When carrying out work on electrical systems, ensuring people's safety and preventing damage to equipment and system components are top priorities. Although safety rules and processes have not yet been standardised around the world, users know that safe working can only be guaranteed when several factors come together:

- Consistent observance of rules and instructions
- Rigorous and continuously updated training of personnel
- Mutual trust when working on electrical systems
- Use of reliable tools and work equipment

PFISTERER represents decades of experience in developing safety equipment with a practical focus. We know how users think and work. Our highly skilled development, production and test lab teams put this knowledge into practice, every day. The result is reliable safety equipment with a focus on our customers' requirements.

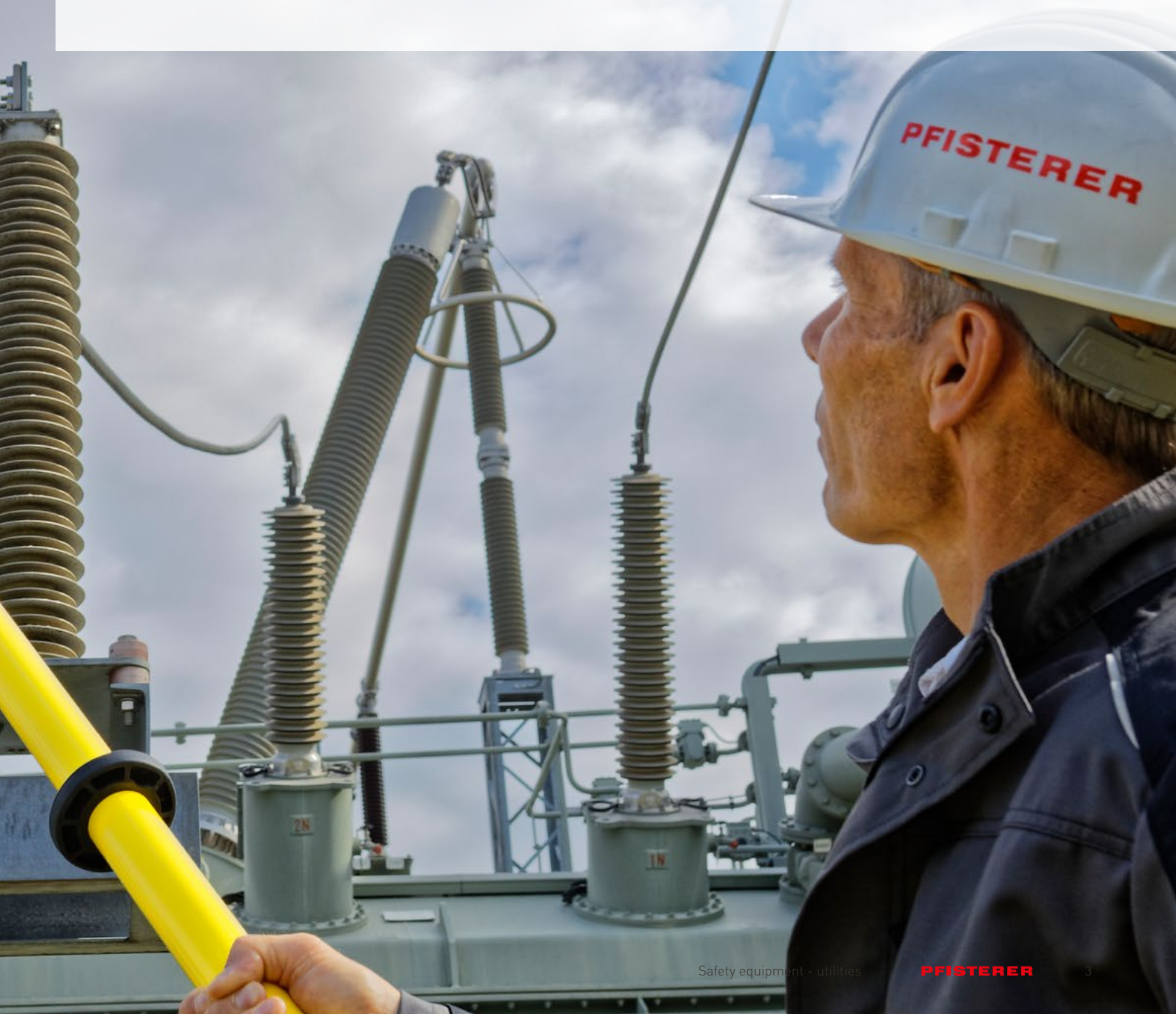

Contents

1

Voltage detectors and phase comparators

- 1.1 Voltage detectors 08
- 1.2 Phase comparators 16
- 1.3 Accessories for voltage detectors and phase comparators 19
- 1.4 Servicing for voltage detectors and phase comparators 24

2

Earthing and short-circuiting devices

- 2.1 Earthing and short-circuiting devices..... 28
- 2.2 Earthing and line clamps..... 40
- 2.3 Earthing and line fixed points..... 46
- 2.4 Accessories for earthing and short-circuiting devices 55

3

Earthing and operating poles

- 3.1 Earthing poles..... 58
- 3.2 Operating poles 64
- 3.3 Accessories for earthing and operating poles..... 68

4

Voltage detecting systems

- 4.1 Single-phase voltage detecting systems 72
- 4.2 Three-phase voltage detecting systems 74
- 4.3 Test devices for voltage detecting systems..... 76



This product catalogue contains a representative selection of the most popular products from our range. You will find further variants in our online catalogue, which you can access conveniently via the red QR codes. We also offer additional versions and custom applications on request.



[catalogue.pfisterer.com/
en/safety-equipment/](https://catalogue.pfisterer.com/en/safety-equipment/)

Voltage detection – simple, safe, reliable



Is the operating voltage present or not present? To answer this question unambiguously, reliable voltage detectors with clear signalling are required. They are the crucial factor in preventing accidents and protecting people and property. PFISTERER

knows what matters, and combines 100 percent safety with maximum cost-effectiveness.



Quality and durability

PFISTERER voltage detectors represent quality and durability – for more than 50 years. The KP-Test 5 series are well engineered products that have been tried and tested in practice. Each device undergoes 100% factory functional testing.

Dual devices

The detection range of KP-Test 5 voltage detectors is adapted to each customer's specific requirements. As well as devices for a specific rated voltage or rated voltage range, dual versions of the voltage detectors are also available. These are switchable and can detect two different rated voltage ranges.

Double certainty

A clear indication of the test result is essential to prevent accidents. That is why PFISTERER uses the proven dual visible and audible signalling system.

Active switch-on

The active switch-on of our voltage detectors is an essential safety feature from PFISTERER. We are certain: only by actively switching on your device and receiving direct feedback from it can you be sure that it is working properly.



1.1 Voltage detectors

KP-Test 5 / KP-Test 5 dual

The KP-Test 5 capacitive voltage detector is used on **medium voltage switchgear** and **medium voltage overhead lines**. It can be used both indoors and outdoors. Devices are available for testing one rated voltage or a rated voltage range.

The KP-Test 5 dual capacitive voltage detector can be switched between two rated voltage ranges but otherwise is identical in design to the KP-Test 5.

- Voltage ranges between: **1 and 36 kV**
- Rated frequency: **50 Hz**
- Designed and type-tested in accordance with **IEC 61243-1**
- Length of insulating section (version with insulating pole) 520 mm

Technical description

- Double signalling
- Integrated audible signal
- Extremely bright LEDs
- Maximum resistance to interference fields
- Self-test at switch-on
- Can be used in rain and snow
- Detachable fork electrode for overhead lines included

**KP-Test 5**

Rated voltage U_N (kV)	Overall length L_G (mm)	Immersion depth A_i (mm)	Handle length L_h (mm)	Suitable bag	Suitable case	Article no.
3	887	220	135	A1	K3	930 100 003 / 00020
5	887	220	135	A1	K3	930 100 005 / 00020
10	887	220	135	A1	K3	930 100 010 / 00020
13	1060	393	135	A1	K3	930 110 013 / 00020
20	1060	393	135	A1	K3	930 110 020 / 00020
3 - 10	1270	603	135	A3	K3	930 120 003 / 00020
5 - 6	1060	393	135	A1	K3	930 110 005 / 00020
5 - 10	1270	603	135	A3	K3	930 120 005 / 00020
10 - 12	1060	393	135	A1	K3	930 110 010 / 00020
10 - 20	1270	603	135	A3	K3	930 120 010 / 00020
10 - 30	1730	910	288	A2	K4	930 140 010 / 00020
20 - 36	1730	910	288	A2	K4	930 140 020 / 00020

KP-Test 5 dual

Rated voltage U_N (kV)		Overall length L_G (mm)	Immersion depth A_i (mm)	Handle length L_h (mm)	Suitable bag	Suitable case	Article no.
Level I	Level II						
3 - 10	20 - 36	1730	910	288	A2	K4	930 190 501 / 00138
5 - 12	13 - 36	1730	910	288	A2	K4	930 190 501 / 00069
10 - 20	20 - 36	1730	910	288	A2	K4	930 190 501 / 00109

Versions with different rated voltages, rated voltage ranges, frequencies and languages can be found in our online catalogue or are available on request.



The KP-Test 5i capacitive voltage detector is specially designed for **medium voltage substation** and is suitable for indoor use only.

- Voltage ranges between: **5 and 20 kV**
- Rated frequency: **50 Hz**
- Designed and type-tested in accordance with **IEC 61243-1**
- Permanently integrated insulating pole

Technical description

- Visible signalling
- Extremely bright LEDs
- Maximum resistance to interference fields
- Self-test at switch-on
- Suitable for indoor use only

KP-Test 5i

Rated voltage U_N (kV)	Overall length L_G (mm)	Immersion depth A_i (mm)	Handle length L_h (mm)	Article no.
5 - 10	1270	450	135	930 150 005 / 00015
10 - 20	1270	450	135	930 150 005 / 00014

Versions with different rated voltages, rated voltage ranges, frequencies and languages can be found in our online catalogue or are available on request.

Reference graphic for all voltage detectors

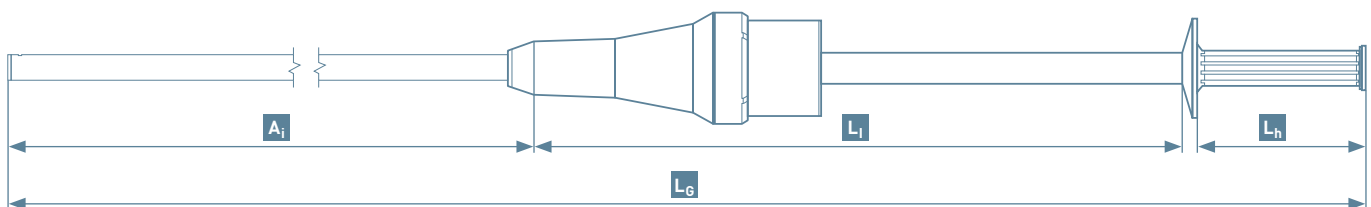

A_i Immersion depth
 L_G Overall length

L_i Length of insulating section
 L_h Handle length

KP-Test 5A

The KP-Test 5A capacitive voltage detector is designed exclusively for use at capacitive measuring points on outer cone connector systems in accordance with DIN VDE 0278-629-1. The innovative contact electrode attachment can be used to remove voltage tap cover caps prior to testing.

- Voltage ranges between: **3 and 36 kV**
- Rated frequency: **50 Hz**
- Designed and type-tested in accordance with **IEC 61243-1**

Technical description

- Double signalling
- Integrated audible signal
- Extremely bright LEDs
- Maximum resistance to interference fields
- Can be used in rain and snow
- Self-test at switch-on
- Detachable contact electrode attachment for removing the cover cap



KP-Test 5A

Rated voltage U_N (kV)	Overall length L_G (mm)	Immersion depth A_i (mm)	Handle length L_h (mm)	Suitable bag	Suitable case	Article no.
3.6 - 6	887	220	135	A1	K3	930 190 001 / 00639
10 - 24	887	220	135	A1	K3	930 190 001 / 00640
10 - 36	887	220	135	A1	K3	930 190 001 / 00641
20 - 36	887	220	135	A1	K3	930 190 001 / 00642

Versions with different rated voltages, rated voltage ranges, frequencies and languages can be found in our online catalogue or are available on request.

KP-Test 5L / KP-Test 5L dual



The KP-Test 5L capacitive voltage detector is used on **medium voltage overhead lines**. The KP-Test 5L dual capacitive voltage detector can be switched between two rated voltage ranges but otherwise is identical in design to the KP-Test 5L.

- Voltage ranges between: **3 and 36 kV**
- Rated frequency: **50 Hz**
- Designed and type-tested in accordance with **IEC 61243-1**
- Overall length of the device without insulating pole 345 mm

Technical description

- Double signalling
- Integrated audible signal
- Extremely bright LEDs
- Maximum resistance to interference fields
- Self-test at switch-on
- Can be used in rain and snow
- Available as "separate device" without insulating pole

KP-Test 5L

Rated voltage U_N (kV)	Suitable bag	Suitable case	Article no.
10 - 20	A4	K1	930 210 001 / 00113
20 - 36	A4	K1	930 210 001 / 00109

KP-Test 5L dual

Rated voltage U_N (kV)		Suitable bag	Suitable case	Article no.
Level I	Level II			
5 - 10	20 - 36	A4	K1	930 210 501 / 00039
3 - 6	20 - 36	A4	K1	930 210 501 / 00041

Versions with different rated voltages, rated voltage ranges, frequencies and languages can be found in our online catalogue or are available on request.

Suitable insulating poles

Length: 725 mm | 973 501 001

Length: 1485 mm | 624 760 001

1.1 Voltage detectors

KP-Test 5H

The KP-Test 5H capacitive voltage detector is used on **high voltage overhead lines** and on **high voltage outdoor switchgear** with rated voltages between 30 and 420 kV.

- Voltage ranges between: **30 and 420 kV**
- Rated frequency: **50 Hz**
- Designed and type-tested in accordance with **IEC 61243-1**
- Immersion depth **A_i = 898 mm**

Technical description

- Double signalling
- Integrated audible signal
- Extremely bright LEDs
- Maximum resistance to interference fields
- Self-test at switch-on
- Can be used in rain and snow
- Available as "complete device" with insulating pole or "separate device" without insulating pole

**KP-Test 5H**

Rated voltage U _N (kV)	Overall length L _G (mm)	Transportation length L _T (mm)	Insulating length L _I (mm)	Suitable bag	Article no.
110	3700	1855	1802	B2	930 250 001 / 00439
30 - 60	2478	1485	975	B5	930 250 001 / 00400
50 - 110	3700	1855	1802	B2	930 250 001 / 00410
60 - 110	3700	1855	1802	B2	930 250 001 / 00447
110 - 220	4418	2050	2520	B2	930 250 001 / 00367
220 - 380	5748	2050	3850	B2	930 250 001 / 00418
220 - 420	5748	2050	3850	B2	930 250 001 / 00312

Versions with different rated voltages, rated voltage ranges, frequencies and languages can be found in our online catalogue or are available on request.

The KP-Test 5 HL capacitive voltage detector is used on **high voltage overhead lines** with rated voltages between 30 and 220 kV.



- Voltage ranges between: **30 and 220 kV**
- Rated frequency: **50 Hz**
- Designed and type-tested in accordance with **IEC 61243-1**

Technical description

- Double signalling
- Integrated audible signal
- Extremely bright LEDs
- Maximum resistance to interference fields
- Self-test at switch-on
- Can be used in rain and snow
- Available as "separate device" without insulating pole

KP-Test 5HL

Rated voltage U_N (kV)	Hook electrode diameter (mm)	Suitable case	Article no.
50 - 150	70	K2	930 200 002 / 00098
110 - 220	70	K2	930 200 002 / 00063

Versions with different rated voltages, rated voltage ranges, frequencies and languages can be found in our online catalogue or are available on request.

Minimum length of insulating element according to EN 61243-1

U_r (kV)	L_i (mm)
$1 < U_r \leq 36$	520
$36 < U_r \leq 72.5$	830
$72.5 < U_r \leq 123$	1300
$123 < U_r \leq 170$	1700
$170 < U_r \leq 245$	2300
$245 < U_r \leq 420$	3600

U_r = Rated voltage

L_i = Minimum length of insulating element acc. to EN 61243-1

See table for minimum requirements for insulation characteristics and the minimum length of insulating elements for voltage detectors sold as "separate devices". This also applies to insulating poles provided by the operator.

1.1 Voltage detectors

KP-Test 5D dual

The KP-Test 5D dual is a distance voltage detector for use on **high voltage overhead lines** with rated voltages between 110 and 420 kV. When placed on the earthed protective fitting (corona ring), it indicates whether operating voltage is present or not.

In addition, this distance voltage detector is switchable between two rated voltage ranges. This allows a larger network range to be covered with the same resistance to interference fields. A proportional audible warning signal indicates at an early stage that the device is approaching a live conductor.

- Voltage ranges between: **110 and 420 kV**
- Rated frequency: **50 Hz**
- Designed and type-tested in accordance with **DIN VDE V 0682-417**

Technical description

- Double signalling
- Integrated audible signal
- Extremely bright LEDs
- Proportional audible warning signal
- Maximum resistance to interference fields
- Self-test at switch-on
- Can be used in rain and snow

**KP-Test 5D dual**

Rated voltage U_N (kV)		Overall length L_G (mm)	Transportation length L_T (mm)	Insulating length L_i (mm)	Including carrying bag	Article no.
Level I	Level II					
110	220 - 420	980	980	520	—	930 470 501 / 00015
110	220 - 420	980	980	520	C1	930 470 501 / 00010

Versions with different rated voltages, rated voltage ranges, frequencies and languages can be found in our online catalogue or are available on request.



The KP-Test 5HVDC voltage detector is used on **high voltage DC transmission systems** with rated voltages between 140 and 320 kV.

- Voltage ranges between: **±140 and ±320 kV DC**

Technical description

- Double signalling
- Integrated audible signal
- Extremely bright LEDs
- Maximum resistance to interference fields
- Self-test at switch-on
- Can be used in rain and snow
- Available only together with suitable insulating poles

KP-Test 5HVDC

Rated voltage DC U _N (kV)	Overall length L _G (mm)	Transportation length L _T (mm)	Insulating length L _I (mm)	Suitable bag	Article no.
±140	4706	1600	2975	B5	930 490 001 / 00017
±150	4706	1600	2975	B5	930 490 001 / 00018
±250 to ±320	7250	2600	4680	B3	930 490 001 / 00010

Versions with different rated voltages, rated voltage ranges, frequencies and languages can be found in our online catalogue or are available on request.

1.2 Phase comparators

Single-pole phase comparator SPPC 5 / SPPC 5 dual

Phase comparators for medium voltage are used to test for phase equality in **three-phase networks**. The type SPPC 5 single-pole phase comparator is based on the design of the proven PFISTERER voltage detectors. This ensures maximum safety and reliability. Phase comparison is carried out with the SPPC 5 single-pole phase comparator by successively making contact with the two conductors.

- Voltage ranges between: **1 and 36 kV**
- Rated frequency: **50 Hz**
- Designed and type-tested in accordance with **IEC 61481**

Technical description

- Visible signalling
- Green, red and yellow LED indicator
- Maximum resistance to interference fields
- Self-test at switch-on
- Can be used in rain and snow
- Detachable contact electrode attachment as fork electrode



SPPC 5

Rated voltage U_N (kV)	Overall length L_G (mm)	Immersion depth A_i (mm)	Handle length L_h (mm)	Suitable bag	Suitable case	Article no.
20	1270	450	288	A1	K3	930 400 001 / 00140
3 - 6	1270	450	288	A1	K3	930 400 001 / 00137
5 - 10	1270	450	288	A1	K3	930 400 001 / 00138
6 - 12	1270	450	288	A1	K3	930 400 001 / 00115
10 - 20	1270	450	288	A1	K3	930 400 001 / 00139
12 - 24	1270	450	288	A1	K3	930 400 001 / 00141
20 - 36	1730	910	288	A2	K4	930 400 001 / 00091

SPPC 5 dual

Rated voltage U_N (kV)		Overall length L_G (mm)	Immersion depth A_i (mm)	Handle length L_h (mm)	Suitable bag	Suitable case	Article no.
Level I	Level II						
3 - 6	10 - 20	1270	450	288	A1	K3	930 400 501 / 00064
5 - 10	12 - 24	1270	450	288	A1	K3	930 400 501 / 00065
6 - 12	12 - 24	1270	450	288	A1	K3	930 400 501 / 00066
5 - 10	20 - 36	1730	910	288	A2	K4	930 400 501 / 00058

Versions with different rated voltages, rated voltage ranges, frequencies and languages can be found in our online catalogue or are available on request.



For reliable phase comparison, a rated frequency between 49.9 and 50.1 Hz is required, with a maximum frequency drift of 10 mHz/s.



The Deltameter 5 is a measuring device that indicates the voltage difference between two phases in **medium voltage networks**. It indicates the voltage difference between two phases quantitatively on a four-digit segment display with a resolution of 10 V. The Deltameter 5 is therefore a very precise decision-making aid for upcoming switching operations.

- Voltage ranges between: **1 and 13 kV**
- Rated frequency: **50 Hz**
- Length of connecting cable 1000 mm

Technical description

- Visible signalling
- 7-segment 4-digit LED display, digit height 14 mm
- Maximum resistance to interference fields
- Can be used in rain and snow
- 10 V resolution
- Accuracy $\pm 5\%$ of measured value +30 V
- Two-pole design with two insulating poles and two practical handles
- Type A3 imitation leather bag included

Deltameter 5

Rated voltage U_N (kV)	Insulating length L_i (mm)	Overall length L_G (mm)	Transportation length L_T (mm)	Article no.
1 - 13	520	1190	1190	930 450 001 / 00011

Versions with different rated voltages, rated voltage ranges, frequencies and languages can be found in our online catalogue or are available on request.

When interconnecting different medium voltage networks, protective devices may respond due to incorrect phase and voltage levels, even though phase relationship tests with IEC 61481 phase comparators have indicated “phase equality”. In cases like these, the Deltameter 5 can be used to supplement the phase relationship tests with phase comparators.



Electronic phase comparator EPC

The EPC electronic phase comparator allows phase comparisons at interfaces and measuring points. It can be used for the HR system as well as the LRM system. The same device can also be used to test for absence of voltage and check the interface.



- Rated frequency: **50 Hz**

Technical description

- Integrated test leads
- Adapter for LRM system included
- Touch-safe testing
- Cable length: 2 m
- Function test and battery check with integrated self-test
- Clear voltage indication by LEDs
- Active phase equality indication by two coloured LEDs
- Built-in safety function and interface check
- Manual or automatic device shutdown

EPC

Rated frequency f_N (Hz)	Application	Adapter for HR systems included	Bag included	Article no.
50 - 60	LRM	827 217 002	970 318 003	827 189 008 / 00038
50 - 60	LRM	827 217 002	364 889 001	827 189 008 / 00040

Optionally available adapters for HR interfaces

Two-pole adapter from LRM to HR system | 827 217 002

Single-pole adapter from LRM to HR system | 827 217 003



Bag type 1 | 970 318 003



Bag type 2 | 364 889 001

Insulating pole extension / cases



Insulating pole extension for voltage detectors

With the insulating pole extension, KP-Test 5, KP-Test 5 dual, KP-Test 5L and KP-Test 5L dual voltage detectors can be easily extended. The extension screws onto the existing insulating pole.

Overall length L _G (mm)	Diameter of insulating section d (mm)	Article no.
560	24	620 518 002
1060	24	620 518 001
2060	24	620 518 003



Storage case – type K1

- Suitable for voltage detector KP-Test 5L
- Hard case made of impact-resistant plastic
- Foam insert for voltage detector and associated adapters

Width (mm)	Height (mm)	Depth (mm)	Weight (g)	Type	Article no.
444	320	108	1700	K1	900 075 001



Storage case – type K2

- Suitable for voltage detector KP-Test 5 HL
- Metal case
- Two toggle latches

Width (mm)	Height (mm)	Depth (mm)	Weight (g)	Type	Article no.
290	160	100	1900	K2	900 076 001



Storage case – type K3/4

- Suitable for KP-Test 5, KP-Test 5 dual voltage detectors and SPPC 5, SPPC 5 dual phase comparators
- Hard case made of impact-resistant plastic
- Aluminium edge protection
- Foam insert for voltage detector and associated adapters

Width (mm)	Height (mm)	Depth (mm)	Weight (g)	Type	Article no.
900	110	260	3470	K3	900 073 007
1250	100	260	4630	K4	900 073 008

Storage bags

Storage bag – type A

- Hard-wearing imitation leather
- Zip closure
- Carrying strap

Length (mm)	Height (mm)	Type	Article no.
500	260	A4	364 887 005
730	260	A1	364 887 002
1000	260	A3	364 887 004
1240	260	A2	364 887 003



Storage bag – type B

- Hard-wearing imitation leather
- Quick-release buckles
- Two shoulder straps

Length (mm)	Height (mm)	Type	Article no.
1260	300	B1	364 888 001
1600	300	B5	364 888 005
2100	300	B2	364 888 002
2600	300	B3	364 888 003
3200	300	B4	364 888 004



Storage bag – type C

- Suitable for voltage detector KP-Test 5D
- Hard-wearing imitation leather
- Zip closure
- Shoulder strap

Length (mm)	Height (mm)	Type	Article no.
730	260	C1	364 888 020



Storage bag – EPC

- Hard-wearing material
- Zip closure
- Carrying strap

Length (mm)	Height (mm)	Depth (mm)	Weight (g)	Article no.
320	240	125	500	364 889 001



Test electrode attachments



Fork electrode

- Can be used on all devices in KP-Test 5 / SPPC 5 series

Article no.
973 210 001



Angled type, 90°

- Can be used on all devices in KP-Test 5 series
- Only for indoor installations

Rated voltage U_N (kV)	Overall length (mm)	Article no.
3 - 36	214 + 370	935 000 001



Type for special switchgear, type I

- Can be used on all devices in KP-Test 5 series
- For use on various Eaton, Holec and Magnefix switchgear
- Only for indoor installations

Rated voltage U_N (kV)	Overall length (mm)	Article no.
3 - 15	204	935 000 003



Type for special switchgear, type II

- Can be used on all devices in KP-Test 5 series
- For use on various Calor Emag, Isopond and Krone/KES switchgear with 11 mm diameter
- Only for indoor installations

Rated voltage U_N (kV)	Overall length (mm)	Article no.
3 - 24	420	935 000 004
3 - 24	890	935 000 007



Type for special switchgear, type III

- Can be used on all devices in KP-Test 5 series
- For use on switchgear with 5.5 mm diameter
- Only for indoor installations

Rated voltage U_N (kV)	Overall length (mm)	Article no.
1 - 10	215	935 000 005

Wall holders

Flexible wall holder

Wall holders for holding and space-saving storage of voltage detectors, phase comparators and insulating poles.

- Holder made of impact-resistant plastic
- Retaining strap made of hard-wearing rubber
- Mount on guide rail 360 330 102 or directly on a wall

Pole diameter (mm)	Article no.
20 - 30	360 330 100
30 - 40	360 330 101



Guide rail for flexible wall holders

Aluminium guide rail for flexible wall holders
360 330 100 and 360 330 101

Length (mm)	Article no.
900	360 330 102



Fastening clips

Fastening clips for holding and space-saving storage of voltage detectors, phase comparators and insulating poles

Pole diameter (mm)	Article no.
21 - 24	360 330 110
25 - 29	360 330 111
29 - 33	360 330 112
34 - 38	360 330 113
39 - 43	360 330 114



Quiver

Quiver as support for pole diameters up to 38 mm

Article no.
360 330 115



Adapters for voltage detectors



Single-pole voltage detectors in the KP-Test 5 series are available as “complete devices” (with insulating poles) or “separate devices” (without insulating poles). For devices supplied separately, users provide their own insulating poles, which must meet the minimum requirements for insulation characteristics and the minimum length of insulating elements.

PFISTERER offers a range of adapters that can be used to attach KP-Test 5 voltage detectors (when supplied as “separate devices”) to insulating poles with various connection types.

Adapters – series C1

Adapter from PFISTERER hex to various other systems

Type	Description	Article no.
C1A	SW 19 – Universal toothed coupling with slot	935 100 001
C1B	SW 19 – DIN spindle type “D”	935 100 002
C1C	SW 19 – Hexagonal SW 12 (aluminium)	935 100 003
C1D	SW 19 – Twin button	935 100 004
C1E	SW 19 – Universal toothed coupling with M8 thread	935 100 005
C1I	SW 19 – DIN spindle type “M”	935 100 008
C1K	SW 19 – Hexagonal SW 12 (plastic)	935 100 009



Adapters – series C2

Adapter from universal adapter toothed coupling M8 to various other systems. Can also be used with KP-Test 5HL

Type	Description	Article no.
C2A	Universal – Universal toothed coupling with M8 thread	935 101 001
C2B	Universal – DIN spindle type “D”	935 101 002
C2C	Universal – Hexagonal SW 12	935 101 003
C2D	Universal – Twin button	935 101 004
C2F	Universal – SW 19 socket	935 101 005

Maintenance inspections

System operators are responsible for the safety of people and equipment, as well as the proper condition of work equipment used. To prevent hazards arising due to faulty equipment, health and safety legislation prescribes regular inspections.

Proven safety with PFISTERER

Maintenance inspections for voltage detectors in accordance with IEC 61243 are mandatory in Germany under DGUV V3 (accident prevention regulations for electrical installations and equipment). The regulations state that voltage detectors must undergo a maintenance inspection with specified test sequences after a maximum period of six years.



More information online

All-inclusive package

PFISTERER has been successfully carrying out these maintenance inspections in its own testing facilities for many years.

PFISTERER also offers its customers a reminder service, which reminds customers by email that a maintenance inspection is due.

PFISTERER services offered

- Maintenance inspection
- Maintenance inspection plus repair
- Maintenance inspection of third-party equipment*

* Without repair and overhaul

Some of the test components

- Visual and dimensional check
- Testing of the self-test device
- Leakage current test
- Protection against bridging and spark resistance
- Measurement and documentation of the threshold voltage

Detailed information about the services we offer is available on request in our "maintenance inspection" price list.

Contact for maintenance inspections

Phone: +49 7323 83 634

+49 7323 83 815

Email: service-whp@pfisterer.com

PFISTERER Kontaktsysteme GmbH
Maintenance inspection department
Bahnhofstrasse 30
89547 Gerstetten-Gussenstadt
Germany



Test protocol		PFISTERER	
for in-service test		Kontaktsysteme GmbH Rosenstrasse 44 73650 Winterbach	
Order number: 104001792	Customer ref: 4201278957-K4-V40	Date: 17.07.2017	
Manufacturer: PFISTERER			
Type: KP-Test II USE 365 431-026		Variant:	Year of manufacturing: 1998
Voltage / frequency range: 3-6 / 10-15 / 25-30 kV 50 Hz		Serial number: 60562	
note:			
Executed tests:			Test result OK
► Visual and dimensional check			
- Device complete			Ja
- No Mechanical damage			Ja
- Labeling complete and readable			Ja
- Red ring available			Ja
- Instruction manual available			Ja
- General condition of device well			Ja
► Check self-testing procedure			Ja
► Leakage current test (dry condition) 1 min. nominal value: < 200µA			3,4µA
► Bridging test (flashover and breakdown)			Ja
► Spark-over test			Ja
► Measurement of operating voltage			
For concerned voltage detector with nominal voltage of:		3-6 / 10-15 / 25-30 kV 50 Hz	
operating voltage "Ut" has been measured:		0,65 / 2,12 / 4,35 kV	
According to DIN VDE 0681 part 4 chapter 4.19.5. Comply also test requirement according to EN 61243-1 chapter 6.2.1.			
► Perceptibility of display		- Optically	Ja
		- Acoustically	
In-service test has been passed according to IEC 61243-1:2003.			
This is to certify that the necessary measures have been respected for quality assurance. The device meets the requirements of o.a. Standards or specifications.		Certified by: Mathias Schmid	
		Date: 17.07.2017	
In-service test passed successfully:			Ja
Next in-service test at the latest:			2023

Example of an inspection report

Best protection in the event of a fault



Earthing and short-circuiting are essential when working on electrical systems and overhead lines. In the event of a fault, components that have been inadvertently re-energised are short-circuited, preventing a dangerous contact voltage for people and equipment. In addition to earthing and short-circuiting devices for medium and high voltage levels, PFISTERER also offers special earthing devices for special applications.



Compliant with IEC 61230

Portable equipment for earthing or earthing and short-circuiting means equipment, devices and components used manually and without forced guidance brought up to and connected to the connection points of parts of electrical systems for the purpose of earthing and short-circuiting. This comprises earthing and short-circuiting devices and equipment including line and earthing clamps as well as earthing poles.

PFISTERER earthing and short-circuiting devices are designed and manufactured in accordance with IEC 61230 to meet individual customer requirements. Specially developed IT-assisted production processes enable short delivery times – even for special variants.

For a one-time load only

Earthing and short-circuiting devices are an essential component for working according to the five safety rules. To ensure reliable protection in the event of a fault, earthing and short-circuiting devices must be individually matched to the intended application.

Normally, earthing and short-circuiting devices are not energised. Once earthing and short-circuiting devices, including their fixing points, have been subjected to a short-circuit current, they must not be used again.



Method of determining the earthing and short-circuiting device

1. Number of conductors to be earthed

PFISTERER offers earthing and short-circuiting devices with one to five poles. For example, if all three conductors in a three-phase system have to be earthed, a 3-phase earthing and short-circuiting device should be selected.

2. Short-circuit current of the system

The maximum short-circuit current of the system must be known in order to dimension the required cable cross-section. The short-circuiting cables of multi-pole earthing and short-circuiting devices must have the same cross-sections.

Earthing and short-circuiting devices are generally only designed for a **single load** with the rated short-circuit current.

Short-circuiting/earthing cable		Maximum short-circuit current (kA) over time (s)		
Solid grounding	Compensated system (resistance grounding)	> 0.5	1	2
25 / 25	25 / 25	7	4.9	3.5
35 / 25	35 / 35	10	6.9	4.9
50 / 50	50 / 25	14	9.9	7
70 / 70	70 / 35	19.5	13.8	9.8
95 / 95	95 / 35	26.5	18.7	13.2
120 / 120	120 / 50	33.5	23.7	16.7
150 / 150	150 / 50	42	29.6	20.9

3. Cable length and cross-section

The length of the cables can be dimensioned individually according to requirements. The length of an earthing and short-circuiting device should be at least 1.2 times the distance between two connection points. Furthermore, the cable lengths should be kept as short as possible, as they will swing out strongly in the event of a short-circuit.

Earthing and short-circuiting devices are available in single to 5-pole versions with the following types of cable insulation:

- PVC (transparent) standard
- TPE (orange)

4. Line clamp

The maximum short-circuit current (I_k/s) must be the same for the earthing and short-circuiting cables and for the clamps. The line clamp connects the earthing and short-circuiting cable to the conductor to be earthed. To find appropriate line clamps, refer to the overview tables.

5. Earthing clamp

The maximum short-circuit current (I_k/s) must be the same for the earthing and short-circuiting cables and for the clamps. The earthing clamp connects the earthing cable to the earthing system connection point. To find appropriate earthing clamps, refer to the overview tables.

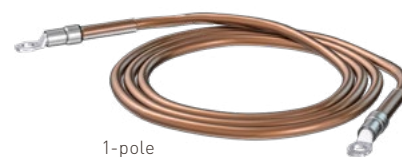

1-pole



2-pole



3-pole



4-pole



6. Replaceability

As well as providing protection against touch contact, the connecting cluster is produced in a signal colour to ensure good and early recognition that an earthing and short-circuiting device is installed in a system. If necessary, mechanically damaged cable sections can be replaced by PFISTERER or cost-effectively by the user, following the instructions for use.

7. Durability

Extensive and long-lasting protection against moisture ingress is achieved by crimping the insulation of the earthing cable in the rear, widened area of the compression cable lug.

Practical advice

If earthing and short-circuiting devices with cables are connected in parallel to achieve certain total cable cross-sections, the following conditions must be met:

- Same cable lengths and cross-sections
- Identical connection parts and connection points
- Installation of the devices close to each other with cables running parallel to each other
- For each cable, the maximum load capacity is reduced to 75% of the load capacity corresponding to the cable cross-section

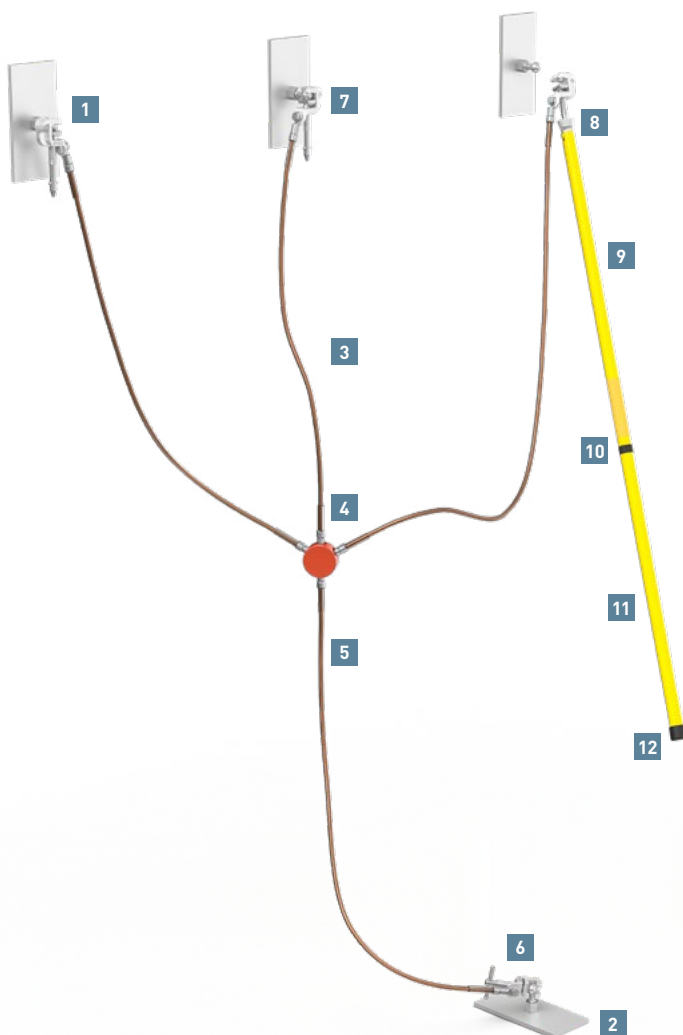

Application example earthing and short-circuiting device

System components

- 1 Conductor with line fixed point
- 2 Earthing system with earthing fixed point

Earthing and short-circuiting device

- 3 Short-circuiting cable
- 4 Connecting cluster
- 5 Earthing cable

Earthing and line clamps

- 6 Earthing clamp
- 7 Line clamp

Earthing pole

- 8 Operating head
- 9 Insulating section
- 10 Black marking
- 11 Handle
- 12 End plug

2.1 Earthing and short-circuiting devices

Single-pole earthing and short-circuiting cables

PFISTERER offers maximum flexibility for custom configuration of earthing and short-circuiting devices. With a choice of more than 25 line and earthing clamps, conductor cross-sections of 25 - 150 mm² are available in any desired length.



The standard cable length with compression cable lugs fitted on both ends is:

- Earthing cable: c = 5000 mm

Single-pole earthing and short-circuiting cables

Cable cross-section (mm ²)	Max. short-circuit current I_k 1s (kA)	Max. short-circuit current I_k 0.5s (kA)	Article no.
25	4.9	7	369 201 001 / 05687
35	6.9	10	369 201 001 / 05688
50	9.9	14	369 201 001 / 05689
70	13.8	19.5	369 201 001 / 05690
95	18.7	26.5	369 201 001 / 03525
120	23.7	33.5	369 201 001 / 05112
150	29.6	42	369 201 001 / 04537

You will find further variants in our online catalogue. Different application-specific configurations with other cable types, cable cross-sections, cable lengths or line and earthing clamps are available after completing and sending us the data sheet for specifying earthing and short-circuiting devices (see page 70).



Regular inspection of earthing and short-circuiting devices

For reliable protection in the event of a fault, earthing and short-circuiting devices must be in perfect condition. The user should therefore carry out a visual inspection before each use. If this inspection results in even the slightest doubt about the condition of the device, it must not be used. The earthing and short-circuiting device must then be replaced either completely or in parts – clamps or cables.

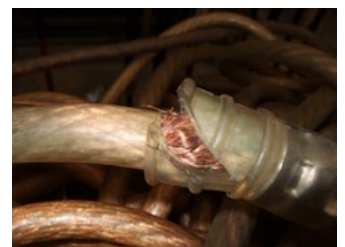

2-pole earthing and short-circuiting devices

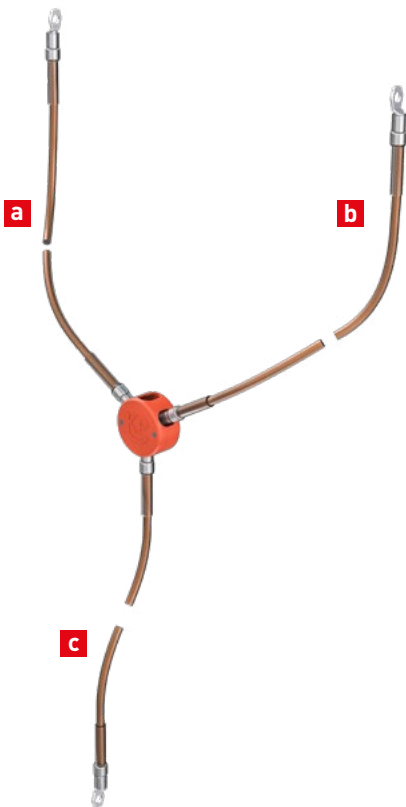

PFISTERER offers maximum flexibility for custom configuration of earthing and short-circuiting devices. With a choice of more than 25 line and earthing clamps, conductor cross-sections of 25 - 150 mm² are available in any desired length.

The standard cable lengths with compression cable lugs fitted on both ends are:

- Short-circuiting cables:
 - a = 1000 mm
 - b = 1000 mm
- Earthing cable:
 - c = 2000 mm

2-pole earthing and short-circuiting devices

Short-circuiting cable cross-section (mm ²)	Earthing cable cross-section (mm ²)	Max. short-circuit current I_k 1s (kA)	Max. short-circuit current I_k 0.5 s (kA)	Article no.
25	25	4.9	7	369 100 001 / 00360
35	35	6.9	10	369 100 001 / 00361
50	50	9.9	14	369 100 001 / 00362
70	70	13.8	19.5	369 100 001 / 00363
95	95	18.7	26.5	369 100 001 / 00364
120	120	23.7	33.5	369 100 001 / 00365
150	150	29.6	42	369 100 001 / 00366

You will find further variants in our online catalogue. Different application-specific configurations with other cable types, cable cross-sections, cable lengths or line and earthing clamps are available after completing and sending us the data sheet for specifying earthing and short-circuiting devices (see page 70).



Do not use, replace if:

- Cable lug twisted or damaged
- Insulation broken
- Signs of wear on the penetrating clamp
- Thread dirty and/or turns stiffly
- Deformation of the handle
- Short-circuit load

2.1 Earthing and short-circuiting devices

2

3-pole earthing and short-circuiting devices with reduced cross-section earthing cable

PFISTERER offers maximum flexibility for custom configuration of earthing and short-circuiting devices. With a choice of more than 25 line and earthing clamps, conductor cross-sections of 25 - 150 mm² are available in any desired length.

The standard cable lengths with compression cable lugs fitted on both ends are:

- Short-circuiting cables:
 - a = 600 mm
 - b = 600 mm
 - d = 600 mm
- Earthing cable:
 - c = 1500 mm

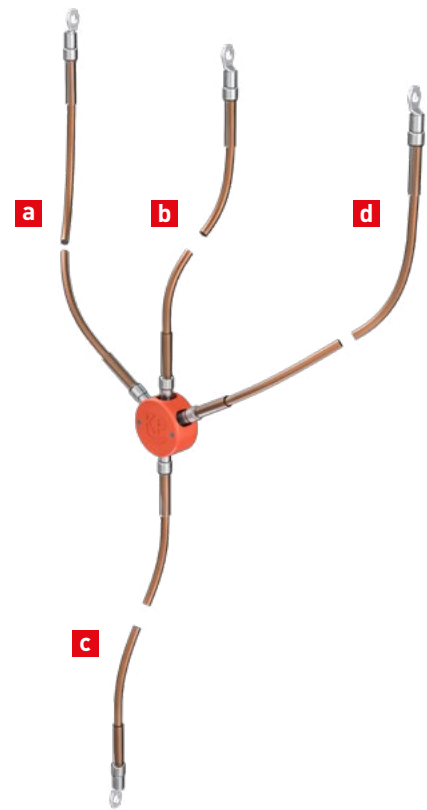

3-pole earthing and short-circuiting devices with reduced cross-section earthing cable

Short-circuiting cable cross-section (mm ²)	Earthing cable cross-section (mm ²)	Max. short-circuit current I_k 1s (kA)	Max. short-circuit current I_k 0.5 s (kA)	Article no.
50	25	9.9	14	369 203 001 / 06287
70	35	13.9	19.5	369 203 001 / 06288
95	35	18.7	26.5	369 203 001 / 06289
120	50	23.7	33.5	369 203 001 / 06290
150	50	29.6	42	369 203 001 / 06291

You will find further variants in our online catalogue. Different application-specific configurations with other cable types, cable cross-sections, cable lengths or line and earthing clamps are available after completing and sending us the data sheet for specifying earthing and short-circuiting devices (see page 70).

without reduced cross-section earthing cable

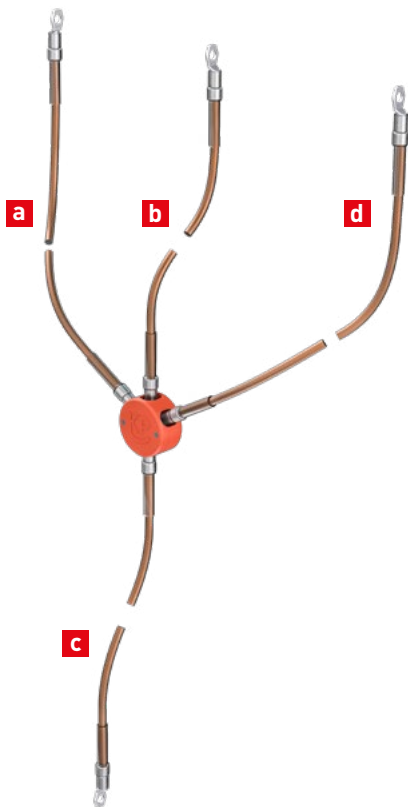

PFISTERER offers maximum flexibility for custom configuration of earthing and short-circuiting devices. With a choice of more than 25 line and earthing clamps, conductor cross-sections of 25 - 150 mm² are available in any desired length.

The standard cable lengths are:

- Short-circuiting cables:
 - a = 600 mm
 - b = 600 mm
 - d = 600 mm
- Earthing cable:
 - c = 1500 mm

3-pole earthing and short-circuiting devices without reduced cross-section earthing cable

Short-circuiting cable cross-section (mm ²)	Earthing cable cross-section (mm ²)	Max. short-circuit current I_k 1s (kA)	Max. short-circuit current I_k 0.5 s (kA)	Article no.
25	25	4.9	7	369 203 001 / 04173
35	35	6.9	10	369 203 001 / 04174
50	50	9.9	14	369 203 001 / 06292
70	70	13.8	19.5	369 203 001 / 06293
95	95	18.7	26.5	369 203 001 / 06294
120	120	23.7	33.5	369 203 001 / 06295
150	150	29.6	42	369 203 001 / 06296

You will find further variants in our online catalogue. Different application-specific configurations with other cable types, cable cross-sections, cable lengths or line and earthing clamps are available after completing and sending us the data sheet for specifying earthing and short-circuiting devices (see page 70).

2.1 Earthing and short-circuiting devices

3-pole earthing and short-circuiting devices for MV CONNEX sockets

These devices can be used to earthing and short-circuit switchgear, transformers and other equipment equipped with MV CONNEX sockets. Suitable for MV CONNEX sockets in accordance with EN 50180, EN 50181, DIN 47637.

The standard cable lengths are

- Short-circuiting cables:
 - a = 600 mm
 - b = 600 mm
 - d = 600 mm
- Earthing cable:
 - c = 1500 mm



3-pole earthing and short-circuiting devices for MV CONNEX sockets

Line clamp for	Earthing clamp	Earthing cable cross-section (mm ²)	Short-circuiting cable cross-section (mm ²)	Max. short-circuit current I_k 1s (kA)	Max. short-circuit current I_k 0.5s (kA)	Article no.
CONNEX socket size 1	U2	150	50	29.6	42	369 203 001 / 06297
CONNEX socket size 2	U2	150	50	29.6	42	369 203 001 / 06298
CONNEX socket size 3	U2	150	50	29.6	42	369 203 001 / 06299

You will find further variants in our online catalogue. Different application-specific configurations with other cable types, cable cross-sections, cable lengths or line and earthing clamps are available after completing and sending us the data sheet for specifying earthing and short-circuiting devices (see page 70).

for MV CONNEX cable connectors

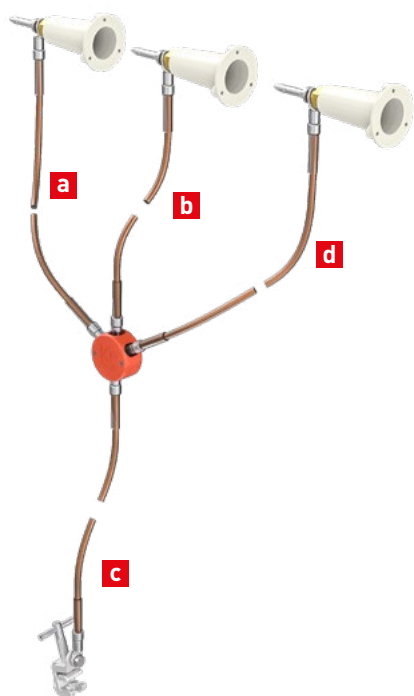

These devices can be used to earthing and short-circuit cables fitted with MV CONNEX cable connectors. Suitable for MV CONNEX cable connectors in accordance with EN 50180, EN 50181, DIN 47637.

The standard cable lengths are

- Short-circuiting cables:
 - a = 600 mm
 - b = 600 mm
 - d = 600 mm
- Earthing cable:
 - c = 1500 mm

3-pole earthing and short-circuiting devices for MV CONNEX sockets

Line clamp for	Earthing clamp	Earthing cable cross-section (mm ²)	Short-circuiting cable cross-section (mm ²)	Max. short-circuit current I_k 1s (kA)	Max. short-circuit current I_k 0.5s (kA)	Article no.
CONNEX plug size 1	U2	150	50	29.6	42	369 203 001 / 06300
CONNEX plug size 2	U2	150	50	29.6	42	369 203 001 / 06301
CONNEX plug size 3	U2	150	50	29.6	42	369 203 001 / 06302

You will find further variants in our online catalogue. Different application-specific configurations with other cable types, cable cross-sections, cable lengths or line and earthing clamps are available after completing and sending us the data sheet for specifying earthing and short-circuiting devices (see page 70).

Discharge poles for high voltage capacitors

These discharge poles make it possible to discharge induced and equalisation voltages on high voltage capacitors.

Technical description

- Glass-fibre reinforced polyester tube in yellow colour
- Fixed copper hook
- Earthing cable with cable lug
- Insulating section $L_i = 500$ mm
- Diameter of insulating section = 24 mm
- Copper hook length = 120 mm
- Copper hook diameter = 8 mm

Discharge poles for high voltage capacitors

Cable cross-section (mm ²)	Cable length (mm)	Pole length (mm)	Article no.
25	2000	1000	363 800 000 / 00104
25	3000	1500	363 800 000 / 00092

Different application-specific versions with other pole and cable lengths or earthing clamps can be found in our online catalogue or are available on request.



for electrostatic filter system

These discharge poles make it possible to discharge induced and equalisation voltages on electrostatic filter system.

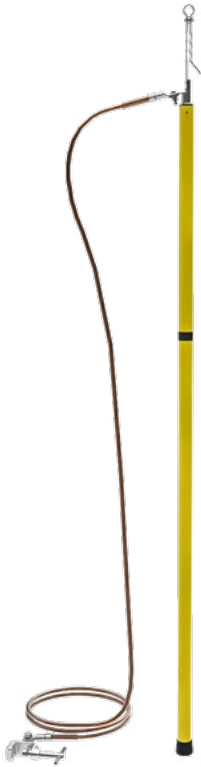

Technical description

- Glass-fibre reinforced polyester tube in yellow colour
- Fixed spring-loaded blade contact
- Earthing cable with earthing clamp type E2
- Insulating section $L_i = 500$ mm
- Diameter of insulating section = 33 mm
- Suitable for mounting on round conductors from 12 - 26.5 mm

Discharge poles for electrostatic filter system

Cable cross-section (mm ²)	Cable length (mm)	Pole length (mm)	Article no.
25	3000	1500	363 800 000 / 00158
25	3000	1500	363 800 000 / 00118
25	5000	2000	363 800 000 / 00159

Different application-specific versions with other pole and cable lengths or earthing clamps can be found in our online catalogue or are available on request.

2.1 Earthing and short-circuiting devices

Earthing and short-circuiting devices for low voltage

These earthing and short-circuiting devices are designed for use on low voltage distribution boards, and in cable cabinets and fuse boxes.

They are available as a set with the components listed below.

Other versions with different cable lengths, types and configurations are available on request.

Case set 1

Case set 1 comprises the following components:

- One 3-pole earthing and short-circuiting device
- Cable cross-section: 25 mm²
- Short-circuiting cables:
 - a = 300 mm
 - b = 600 mm
 - d = 800 mm
- Earthing cable:
 - c = 1000 mm
- Threaded screw connection for earthing cartridges
- Earthing clamp for flat bars with flexible grip and two spindle positions
- 1 earthing grip, 350 mm
- 3 earthing cartridges, size 1 - 3
- 3 earthing cartridges, size 00
- 3 DIAZED fuse elements, size E33
- 1 plastic storage case with foam insert

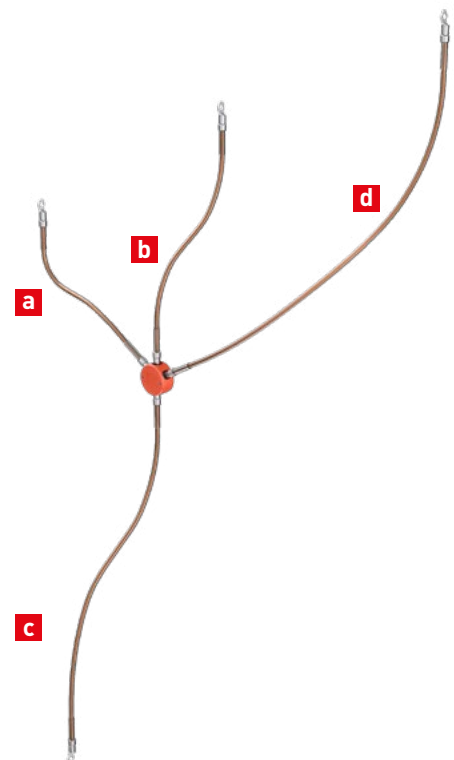

	Article no.
	360 481 100 / 00116

**Case set 2**

Case set 2 comprises the following components:

- Two 3-pole earthing and short-circuiting devices
- Cable cross-section: 25 mm²
- Short-circuiting cables:
 - a = 300 mm
 - b = 600 mm
 - d = 800 mm
- Earthing cable:
 - c = 1000 mm
- Threaded screw connection for earthing cartridges
- Earthing clamp for flat bars with flexible grip and two spindle positions
- 1 earthing grip, 350 mm
- 6 earthing cartridges, size 1 - 3
- 6 earthing cartridges, size 00
- 6 DIAZED fuse elements, size E33
- 1 plastic storage case with foam insert

Article no.
360 481 100 / 00126

**Case set 3**

Case set 3 comprises the following components:

- One 3-pole earthing and short-circuiting device
- Cable cross-section: 25 mm²
- Short-circuiting cables:
 - a = 300 mm
 - b = 600 mm
 - d = 800 mm
- Earthing cable:
 - c = 1000 mm
- Threaded screw connection for earthing cartridges
- Earthing clamp for flat bars with flexible grip and two spindle positions
- 1 earthing grip, 350 mm
- 3 earthing cartridges with electromagnetic interlock, size 1 - 3
- 1 plastic storage case with foam insert

Article no.
360 481 100 / 00095

Earthing clamps

PFISTERER offers a comprehensive range of earthing clamps for earthing and short-circuiting devices. Different versions of these earthing clamps are designed for various earthing connection variants outdoors and in indoor installations.

Technical description

- Clamping ranges \varnothing 2 - 30 mm available
- Short-circuit current-carrying capacity up to 29.6 kA / 1 s
- Compact and robust design
- Easy to use
- Tightening torque: 56 Nm
- Connect to earthing and short-circuiting device with M12 bolt



Care of earthing and line clamps

Regular inspection and care of earthing and short-circuiting devices, including line and earthing clamps, is essential for easy handling and reliable functioning in the event of a fault.

Before each use, the user should visually inspect short-circuiting cables and clamps for possible damage, and remove any slight traces of corrosion at the contact points. After each use, dirt should be removed immediately, the spindle greased, and damaged clamps replaced if necessary.

Pay attention to the following:

- No signs of wear on the penetrating clamp
- Clean thread – remove slight traces of corrosion with a wire brush
- Spindle must turn easily – check by hand
- Lubricate spindle regularly with acid-free grease
- Cable lugs seated straight and securely

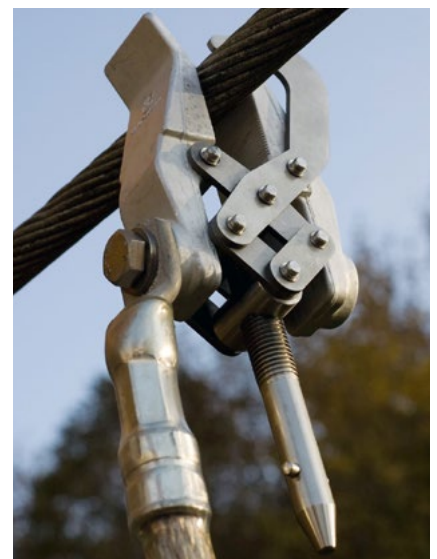







Earthing clamps

Type	Max. cable cross-section (mm ²)						Max. short-circuit current		Clamping range (mm)	Clamping width (mm)	Weight (g)	Article no.
		Ø (mm)	Ø (mm)	Ø (mm)	Ø (mm)	(mm)	I _k 0.5 s (kA)	I _k 1 s (kA)				
	150	—	16	—	—	—	42.0	29.6	16	—	656	364 811 001
A1 Earthing connection socket with wing screw for connection to a cylindrical earthing bolt												
	150	—	16 - 22	—	—	—	42.0	29.6	16 - 22	—	736	364 544 002
A2 Earthing connection socket with screw handle for connection to a cylindrical earthing bolt												
	70	—	—	—	2 - 30	2 - 30	19.5	13.8	2 - 30	—	370	360 419 004
E2 Earthing clamp with screw handle for use e.g. on overhead lines												
	95	—	—	—	2 - 30	2 - 30	26.5	18.7	2 - 30	—	380	360 419 005
E3 Earthing clamp with cutting plate and screw handle for use e.g. on overhead lines												
	50	—	—	—	—	2 - 20	14.0	9.9	2 - 20	—	442	360 416 002
F1 Earthing connection penetrating clamp with screw handle for use on coated masts												
	120	—	—	—	—	2 - 22	33.5	23.7	2 - 22	—	978	360 628 002
F2 Gösag penetrating Earthing clamp with screw handle for use on coated masts												









2.2 Earthing and line clamps

2

Earthing clamps

Type	Max. cable cross-section (mm ²)						Max. short-circuit current		Clamping range (mm)	Clamping width (mm)	Weight (g)	Article no.
		Ø (mm)	Ø (mm)	Ø (mm)	Ø (mm)	(mm)	I _k 0.5 s (kA)	I _k 1 s (kA)				
 <p>U1 Universal earthing clamp with screw handle for use at various earthing connection points</p>	120	20	—	15	5 - 20	2 - 20	33.5	23.7	2 - 20	38	720	360 414 001
 <p>U2 Universal earthing clamp with screw handle for use at various earthing connection points</p>	150	25	—	15	5 - 20	2 - 20	42.0	29.6	2 - 20	38	754	361 346 001
 <p>U3 Universal earthing clamp with handle for use at various earthing connection points</p>	120	20	—	15	5 - 20	2 - 20	33.5	23.7	2 - 20	38	806	364 704 004
 <p>U4 Universal earthing clamp with handle for use at various earthing connection points</p>	150	25	—	15	5 - 20	2 - 20	42.0	29.6	2 - 20	38	836	364 704 003
 <p>U5 Universal earthing clamp with handle for use at various earthing connection points</p>	150	25 - 30	—	20	5 - 25	2 - 25	42.0	29.6	2 - 25	50	902	364 714 002

Earthing clamps

Type	Max. cable cross-section (mm ²)						Max. short-circuit current		Clamping range (mm)	Clamping width (mm)	Weight (g)	Article no.
		Ø (mm)	Ø (mm)	Ø (mm)	Ø (mm)	(mm)	I _k 0.5 s (kA)	I _k 1 s (kA)				
	150	—	—	—	—	—	42.0	29.6	—	—	340	361 659 010
HM12 Earthing clamp with lever and internal thread for M12 bolt												
	150	—	—	—	—	—	42.0	29.6	—	—	340	361 659 012
HM16 Earthing clamp with lever and internal thread for M16 bolt												
	150	—	—	—	—	—	42.0	29.6	—	—	360	361 659 011
HS12 Earthing clamp with lever and bolt for internal M12 thread												
	150	—	—	—	—	—	42.0	29.6	—	—	360	361 659 013
HS16 Earthing clamp with lever and bolt M16 internal thread												









Line clamps

PFISTERER offers a comprehensive range of line clamps for earthing and short-circuiting devices. Depending on the version, these line clamps are designed for connection to overhead lines or in switchgear.







Technical description

- Clamping ranges \varnothing 2 - 85 mm available
- Short-circuit current-carrying capacity up to 29.6 kA / 1 s
- Screw spindle made of A2 stainless steel
- Reliable contact between clamp and conductor
- Compact and robust design
- Easy to use
- Compatible earthing poles available for all versions
- Tightening torque 56 Nm
- Connect to earthing and short-circuiting device with M12 bolt

Line clamps

Type	Max. cable cross-section [mm ²]	 \varnothing (mm)	 \varnothing (mm)	 \varnothing (mm)	 \varnothing (mm)	 (mm)	Max. short-circuit current		Clamping range (mm)	Clamping width (mm)	Weight (g)	Article no.
							I_k 0.5 s (kA)	I_k 1 s (kA)				
	120	20	5 - 20	15	5 - 20	2 - 20	33.5	23.7	2 - 20	38	754	360 330 002
P3D Universal line clamp for various line connection points in switchgear												
	150	25	5 - 20	15	5 - 20	2 - 20	42.0	29.6	2 - 20	38	782	360 332 001
P4D Universal line clamp for various line connection points in switchgear												
	150	25/30	5 - 25	20	5 - 25	2 - 20	42.0	29.6	2 - 25	50	850	360 333 002
P5D Universal line clamp for various line connection points in switchgear												
	120	—	—	—	4 - 23	—	33.5	23.7	4 - 23	27	440	364 309 005
P6D Line clamp for overhead lines and conductor fixed point connections												

Line clamps

Type	Max. cable cross-section (mm ²)						Max. short-circuit current		Clamping range (mm)	Clamping width (mm)	Weight (g)	Article no.
		Ø (mm)	Ø (mm)	Ø (mm)	Ø (mm)	(mm)	I _k 0.5 s (kA)	I _k 1 s (kA)				
 <p>P7D Line clamp for overhead lines and conductor fixed point connections</p>	150	—	—	—	4.5 - 35	—	42.0	29.6	4.5 - 35	34	714	363 245 006
 <p>P8D Line clamp for overhead lines, tubular conductors and conductor fixed point connections</p>	150	—	—	—	10 - 85	—	42.0	29.6	10 - 85	40	886	364 459 009
 <p>P9D Parallel line clamp for slanting attachment to overhead lines</p>	95	—	—	—	10 - 32	10 - 32	26.5	18.7	10 - 32	38	968	360 335 003
 <p>P11D Like P9D parallel line clamp. In addition, this line clamp is equipped with a securing catch that prevents the loosened line clamp from falling down</p>	95	—	—	—	10 - 32	10 - 32	26.5	18.7	10 - 32	38	1010	360 335 004
 <p>P13D Line clamp for high voltage overhead lines</p>	150	—	—	—	15 - 60	—	42.0	29.6	15 - 60	35	900	363 245 010

2.3 Earthing and line fixed points

Earthing and line fixed points with external threaded bolt





For the defined and safe attachment point for earthing and short-circuiting devices, PFISTERER offers a range of both earthing and line fixed points. Special line fixed points are available on request.

Maximum tightening torque:

- M10: 33 Nm
- M12: 56 Nm
- M16: 135 Nm

In accordance with DIN 48088, part 1/2

Earthing and line fixed points with external threaded bolt

Description	External thread	Width across flats (mm)	Max. short-circuit current		Weight (g)	Article no.
			I_k 0.5 s (kA)	I_k 1 s (kA)		
	M12 x 28 mm	22	33.5	23.7	250	360 382 004
	M12 x 38 mm				260	360 382 005
	M12 x 48 mm				270	360 382 006
Ball pin 20 mm straight With external thread						
	M12 x 28 mm	27	42.0	29.6	280	360 384 002
	M12 x 38 mm				290	360 384 003
	M12 x 48 mm				300	360 384 004
Ball pin 25 mm straight With external thread						
	M12 x 38 mm	24	19.5	13.8	210	360 784 001
Ball pin 20 mm angled 45° With external thread						
	M12 x 45 mm	24	26.5	18.7		360 385 001
Ball pin 25 mm angled 90° With external thread						

Earthing and line fixed points with external threaded bolt

Description	External thread	Width across flats (mm)	Max. short-circuit current		Weight (g)	Article no.
			I_k 0.5 s (kA)	I_k 1 s (kA)		
	M12 x 28 mm	—	33.5	23.7	200	360 372 001
	M12 x 48 mm				210	360 372 002

T-bolt 15 mm straight With external thread. Suitable for universal line clamps type U1; U2; U3; U4; P3D; P4D

	M12 x 28 mm	—	42.0	29.6	350	360 386 001
	M12 x 48 mm				360	360 386 002

T-bolt 20 mm straight With external thread. Suitable for universal line clamps type U5; P5; P3D

	M12 x 40 mm	22	42.0	29.6	220	360 407 407
	M16 x 25 mm	27			260	360 408 003
	M16 x 40 mm				280	360 408 408

Cylindrical bolt 16 mm With external thread and annular groove. In accordance with DIN 48088 part 2. Suitable for earthing connection sockets type A1 and A2

2.3 Earthing and line fixed points

Earthing and line fixed points with internal thread





For the defined and safe attachment point for earthing and short-circuiting devices, PFISTERER offers a range of both earthing and line fixed points. Special line fixed points are available on request.

Maximum tightening torque:





- M10: 33 Nm
- M12: 56 Nm
- M16: 135 Nm

In accordance with DIN 48088, part 1/2

Earthing and line fixed points with internal thread

Description	External thread	Width across flats (mm)	Max. short-circuit current		Weight (g)	Article no.
			I_k 0.5 s (kA)	I_k 1 s (kA)		
	M10	22	26.5	18.7	140	612 633 005
	M12		33.5	23.7		612 633 004
	M16	24	33.5	23.7		360 786 003
Ball pin 20 mm straight With internal thread. Suitable for universal line clamp P3D						
	M12	27	42.0	29.6	220	615 820 001
	M16					615 822 001
Ball pin 25 mm straight With internal thread						
	M12	24	19.5	13.8	170	611 370 001
Ball pin 20 mm angled 45° Earthing clamp with handle for use at various earthing connection points						
	M12	27	26.5	18.7	360	360 385 002
Ball pin 25 mm angled 45° With internal thread						

Earthing and line fixed points with internal thread

Description	External thread	Width across flats (mm)	Max. short-circuit current		Weight (g)	Article no.
			I_k 0.5 s (kA)	I_k 1 s (kA)		
	M12	—	33.5	23.7	150	615 805 001
T-bolt 15 mm straight	With internal thread. Suitable for universal line clamps type U1; U2; U3; U4; P3; P3D; P4D					
	M12	—	42.0	29.6	300	610 670 001
T-bolt 20 mm straight	With internal thread. Suitable for universal line clamps type U5; P3; P5					
	M12	22	42.0	29.6	190	610 923 001
	M16	27				615 810 004
Cylindrical bolt 16 mm	With internal thread and annular groove. In accordance with DIN 48088 part 2. Suitable for earthing connection sockets type A1 and A2					
	—	22	42.0	29.6	245	360 409 409
Coupling bolt 16 mm	With annular groove. In accordance with DIN 48088 part 2. Suitable for connection sockets type A1 and A2					

2.3 Earthing and line fixed points





2

Ball pins for 2DIREKT transformer terminal

PFISTERER offers special ball pins for 2DIREKT and 2DIREKT XL transformer terminals for connecting earthing and short-circuiting devices.

Ball pins for the 2DIREKT are equipped with a pressure screw and can be used both in a free conductor channel and to secure a conductor. The ball pin for the 2DIREKT XL is designed without a pressure screw and can only be fitted in free conductor channel.

Ball pin with pressure screw for 2DIREKT (thread: M26x1.5; conductor cross-section: 35 - 240 mm²)

Description	Ball diameter (mm)	Tightening torque (Nm)	Width across flats (mm)	Length (mm)	Max. short-circuit current		Weight (g)	Article no.
					I_k 0.5 s (kA)	I_k 1 s (kA)		
 <p>Short ball pin D20 Pressure screw with short ball pin d = 20 mm for use on 2DIREKT transformer terminal.</p>	20	55	22	70.7	33.5	23.7	200	331 750 100
 <p>Long ball pin D20 Pressure screw with long ball pin d = 20 mm for use on 2DIREKT transformer terminal.</p>	20	55	22	91	33.5	23.7	250	331 750 102
 <p>Short ball pin D25 Pressure screw with short ball pin d = 25 mm for use on 2DIREKT transformer terminal.</p>	25	55	22	80	42.0	29.6	260	331 750 101
 <p>Long ball pin D25 Pressure screw with long ball pin d = 25 mm for use on 2DIREKT transformer terminal.</p>	25	55	22	91	42.0	29.6	280	331 750 103



For applications in conjunction with a cover, a long ball pin should be used.

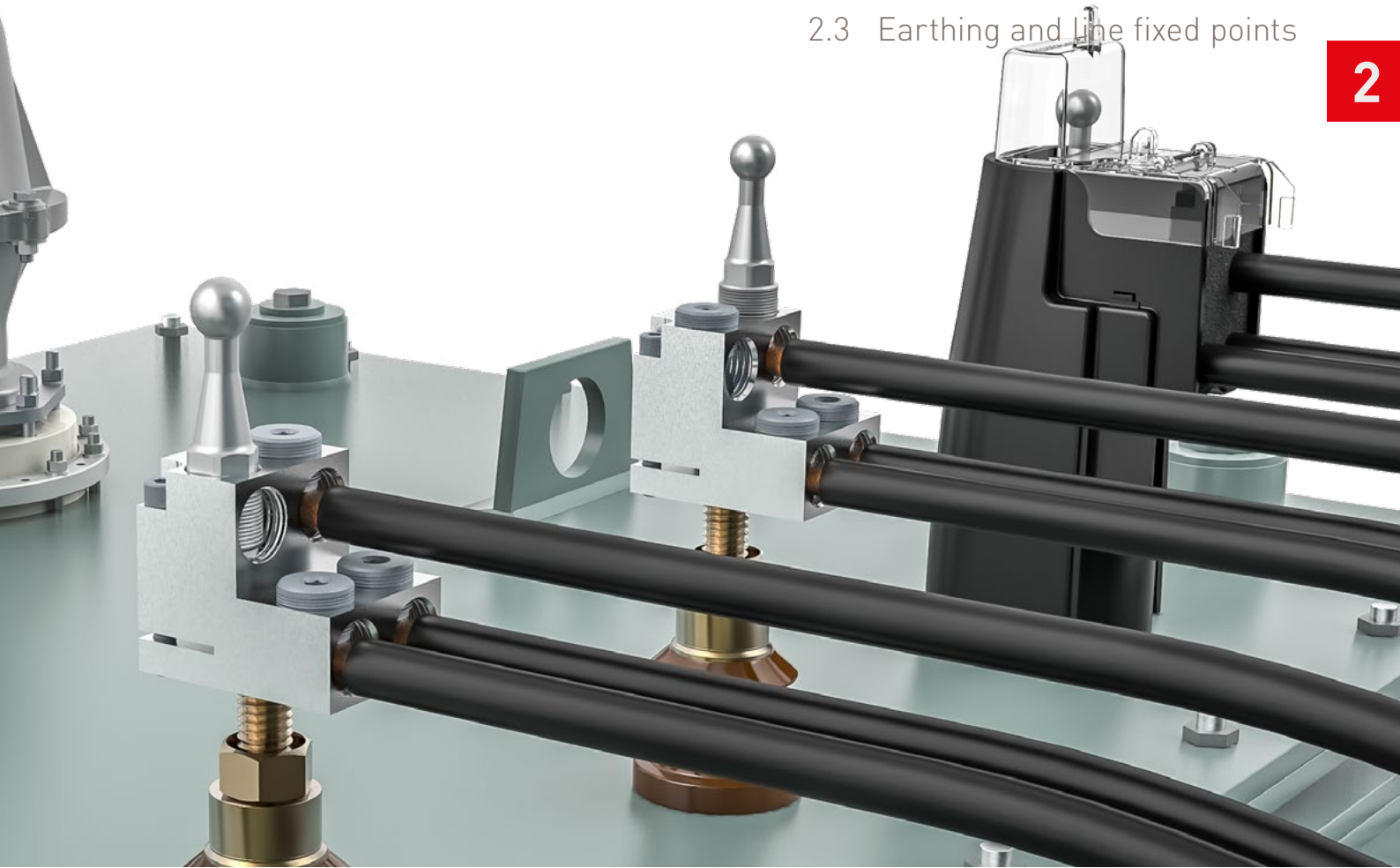

Ball pin for 2DIREKT XL (thread: M33x1.5; conductor cross-section: 185 - 400 mm²)

Description	Ball diameter (mm)	Tightening torque (Nm)	Width across flats (mm)	Length (mm)	Max. short-circuit current		Weight (g)	Article no.
					I_k 0.5 s (kA)	I_k 1 s (kA)		
	25	80	24	107	42.0	29.6	500	332 750 202

Ball pin D25 Without rotatable disc for use in free conductor channels on the 2DIREKT XL transformer terminal.



2DIREKT application
Transformer terminal **without**
conductor connected







2DIREKT application
Transformer terminal **with**
conductor connected



Ball pins for transformer bushings

For the defined connection of earthing and short-circuiting devices directly to transformer bushings, PFISTERER offers ball pins with an internal thread. These ball pins can only be used in conjunction with flat transformer terminals, such as the 2DIREKT single-wire and two-wire transformer terminal clamps.

Ball pins with internal thread (length = 122 mm)

Description	Internal thread	Width across flats (mm)	Max. short-circuit current		Weight (g)	Article no.
			I_k 0.5 s (kA)	I_k 1 s (kA)		
	M20	24	33.5	23.7	300	331 750 001
Ball pin 20 mm	With internal thread for use directly on transformer bushings.					
	M30x2	24	33.5	23.7	360	331 750 002
Ball pin 20 mm	With internal thread for use directly on transformer bushings.					
	M20	24	42.0	29.6	315	331 750 003
Ball pin 25 mm	With internal thread for use directly on transformer bushings.					
	M30x2	24	42.0	29.6	367	331 750 004
Ball pin 25 mm	With internal thread for use directly on transformer bushings.					
	M12	24	42.0	29.6	380	331 750 005
Ball pin 25 mm	With internal thread for use directly on transformer bushings.					



When using flat 2DIREKT terminal clamps in conjunction with a cover, earthing must be done directly via the transformer bushing. In this case only a horizontal conductor outlet is possible.



Before fitting a ball pin, make sure that the transformer bushing protrudes about 10 - 14 mm above the top edge of the transformer terminal clamp.

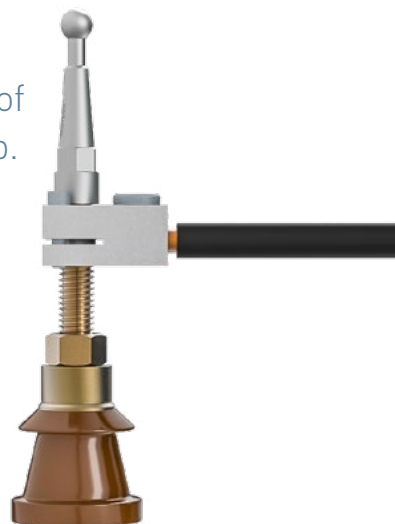
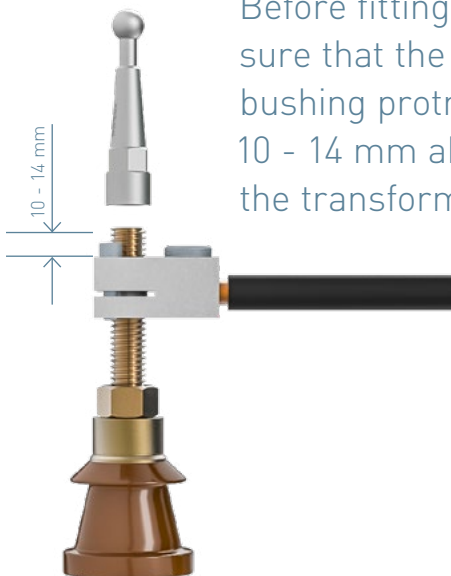

Multi-contact connection devices

Multi-contact connection device A1

Multi-contact connection device A1 suitable for cylindrical bolts 16 mm and for connection of up to three single-pole earthing and short-circuiting devices.

Comprising:

- 1 earthing connection socket A1
- 3 cylindrical earthing bolts with annular groove 16 mm



Max. cable cross-section to be connected (mm ²)	Max. short-circuit current I _k 1 s (kA)	Max. short-circuit current I _k 0.5 s (kA)	Short-circuiting bar L x W x D (mm)	Diameter cylindrical bolt (mm)	Article no.
150	29.6	42.0	195 x 40 x 8	16	364 900 001

Multi-contact connection device A2

Multi-contact connection device A2 suitable for cylindrical bolts 16 - 22 mm and for connection of up to three single-pole earthing and short-circuiting devices.

Comprising:

- 1 earthing connection socket A2
- 3 cylindrical earthing bolts with annular groove 16 mm



Max. cable cross-section to be connected (mm ²)	Max. short-circuit current I _k 1 s (kA)	Max. short-circuit current I _k 0.5 s (kA)	Short-circuiting bar L x W x D (mm)	Diameter cylindrical bolt (mm)	Article no.
150	29.6	42.0	195 x 40 x 8	16 - 22	364 899 001

Multi-contact connection device F2B

Multi-contact connection device F2B suitable for connection to overhead power line towers and for connection of up to four single-pole earthing and short-circuiting devices.

Comprising:

- 1 earthing clamp F2
- 4 cylindrical earthing bolts with annular groove 16 mm.



Max. cable cross-section to be connected (mm ²)	Max. short-circuit current I _k 1 s (kA)	Max. short-circuit current I _k 0.5 s (kA)	Short-circuiting bar L x W x D (mm)	Diameter ball pin (mm)	Article no.
150	29.6	42.0	200 x 40 x 6	25	363 463 463

Multi-contact connection device U2

The multi-contact connection device consists of an earthing clamp U2 and two ball pins with ball diameter 25 mm.

Suitable for connection to ball pin 25 mm, T-bolt 25 mm, round conductor 5 - 20 mm and Cu busbar 2 - 20 mm.



Max. cable cross-section to be connected (mm ²)	Max. short-circuit current I _k 1 s (kA)	Max. short-circuit current I _k 0.5 s (kA)	Short-circuiting bar L x W x D (mm)	Diameter ball pin (mm)	Article no.
150	29.6	42.0	200 x 40 x 6	25	363 463 463

Bags and wall holders



Storage bag for earthing and short-circuiting devices

These storage bags are suitable for the secure transportation and dust-free storage of earthing and short-circuiting devices.

- Hard-wearing imitation leather
- Quick-release buckles
- Two shoulder straps

Length (mm)	Height (mm)	Article no.
400	300	364 785 005
520	350	364 785 001

Wall holder type 1

For storage of earthing and short-circuiting devices as well as 2 earthing or operating poles (diameter 33 mm) in substations.



Width (mm)	Height (mm)	Article no.
360	40	360 877 001

Wall holder type 2

For storage of multi-pole earthing and short-circuiting devices in substations.



Width (mm)	Height (mm)	Article no.
560	250	360 878 001

Wall holder type 3

For storage of single-pole or multi-pole earthing and short-circuiting devices in substations.



Width (mm)	Height (mm)	Article no.
130	100	616 157 157

Working at a safe distance



Operating poles and earthing poles are safety tools. Earthing poles are insulating poles that are used manually. They serve to connect line clamps of earthing and short-circuiting devices to isolated parts of power systems. Operating poles are insulating poles that are used manually for operating and testing live parts.

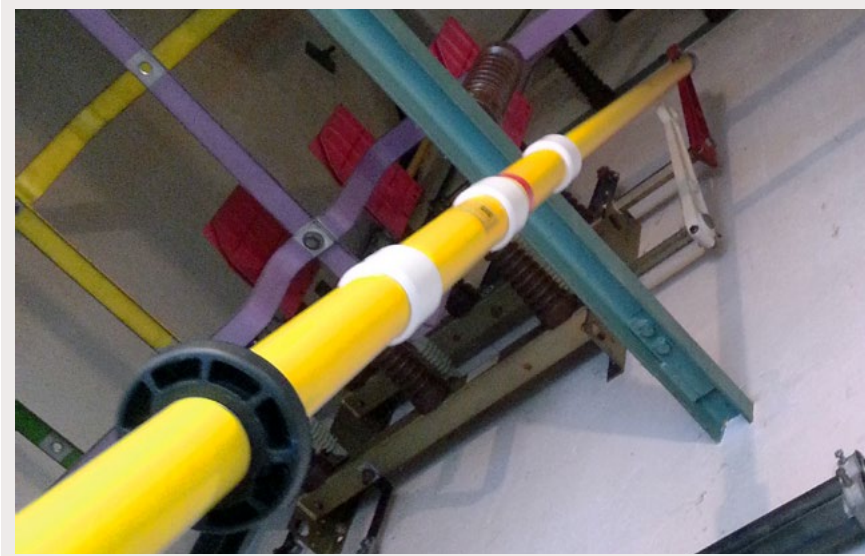

Protection against electrical hazards

Insulating poles have to reliably protect the user when performing switching, testing, or earthing and short-circuiting tasks. Besides the pole material, its length is important as it ensures a sufficient distance between the user and the system part. For reliable protection, among other things, the minimum insulating length of an earthing or operating pole must be selected according to the rated voltage of the system.

Individual for every application

Operating and earthing poles from PFISTERER are manufactured and tested in accordance with the relevant standards. As well as the standard portfolio, PFISTERER offers a modular system that allows every customer to configure their pole individually in line with their applications and requirements.



3.1 Earthing poles

3 Earthing poles

Earthing poles consist of a handle, an insulating section, a black ring and an operating head. The length of the insulating section must be at least 500 mm.

PFISTERER offers a choice of versions with an operating head or with fixed line clamps. The operating head for line clamps with a spindle and cross-pin is available with a **1** roller locking device or with a **2** bayonet lock.

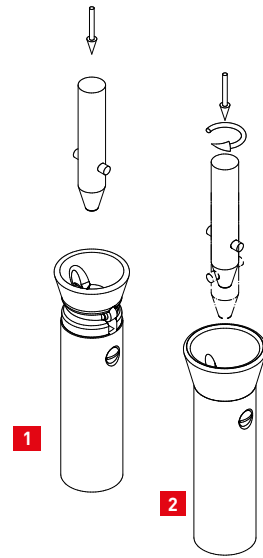

Earthing poles, one-piece with operating head

One-piece earthing pole in different lengths with handle, insulating section, black ring and operating head, optionally with roller locking device or bayonet lock.

Technical description

- Earthing pole made of glass-fibre reinforced polyester tube in yellow colour
- Black marking indicates the necessary safety distance

Pole length (mm)	Diameter of insulating section (mm)	Operating head	Article no.
1038	33	Roller locking device	364 172 001 / 00170
1538	33	Roller locking device	364 172 001 / 00131
2038	33	Roller locking device	364 172 001 / 00135
2538	43	Roller locking device	364 172 001 / 00186
3038	43	Roller locking device	364 172 001 / 00114
3538	43	Roller locking device	364 172 001 / 00132
1038	33	Bayonet lock	364 172 001 / 00214
1538	33	Bayonet lock	364 172 001 / 00116
2038	33	Bayonet lock	364 172 001 / 00234
2538	43	Bayonet lock	364 172 001 / 00290
3038	43	Bayonet lock	364 172 001 / 00291
3538	43	Bayonet lock	364 172 001 / 00292



P4D



P9D



Earthing poles, one-piece with fixed line clamp

One-piece earthing pole in different lengths with handle, insulating section, black ring and fixed line clamp, optionally P4D or P9D.

Technical description

- Earthing pole made of glass-fibre reinforced polyester tube in yellow colour
- Black marking indicates the necessary safety distance

Transportation length (mm)	Diameter of insulating section (mm)	Line clamp	Article no.
1740	33	P9D	364 172 001 / 00293
1650	33	P4D	364 172 001 / 00139

Further variants with different lengths, coupling attachments, fixed line clamps and languages can be found in our online catalogue or are available on request.

Earthing poles with fixed line clamps remain in place at the work site for the entire duration of the work; they serve to visibly mark an area/segment of an electrical system that is short-circuited.



Earthing poles

Earthing poles, telescopic with operating head

Telescopically extendable earthing pole in different lengths with handle, insulating section, black ring and operating head with roller locking device. The telescopic earthing pole enables earthing and short-circuiting devices to be attached at great working heights. An optionally available ring for the end of the pole enables easy and safe handling on overhead power line towers.

Technical description

- Earthing pole made of glass-fibre reinforced polyester tube in yellow colour
- Black marking indicates the necessary safety distance

Pole length extended (mm)	Transportation length (mm)	Operating head	Article no.
1925	1050	Roller locking device	364 172 003 / 00145
2925	1550	Roller locking device	364 172 003 / 00155
3925	2050	Roller locking device	364 172 003 / 00156
4925	2550	Roller locking device	364 172 003 / 00139
5925	3050	Roller locking device	364 172 003 / 00131



Earthing poles, telescopic with fixed line clamp

Telescopically extendable earthing pole in different lengths with handle, insulating section, black ring and fixed line clamp, optionally P7D or P8D.

Technical description

- Earthing pole made of glass-fibre reinforced polyester tube in yellow colour
- Black marking indicates the necessary safety distance

Pole length extended (mm)	Transportation length (mm)	Line clamp	Article no.
2105	1230	P7D	364 172 003 / 00245
4105	2230	P7D	364 172 003 / 00133
2135	1260	P8D	364 172 003 / 00246
4135	2260	P8D	364 172 003 / 00212

Further variants with different lengths, coupling attachments, fixed line clamps and languages can be found in our online catalogue or are available on request.

For more line clamps, see page 42.

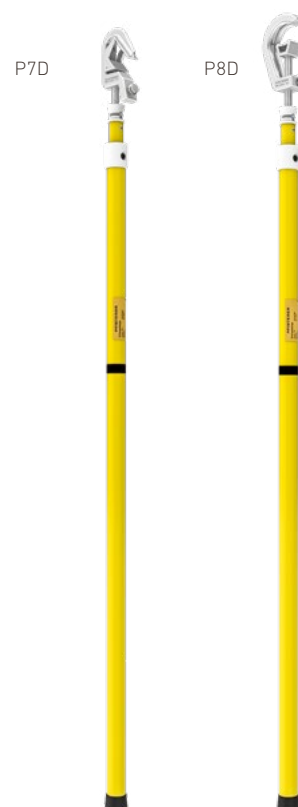

To facilitate the use of telescopic earthing poles on overhead lines, PFISTERER offers a ring which replaces the black cap on the end of the pole. This allows the earthing pole to be pulled up using a rope. This ring can be ordered separately.



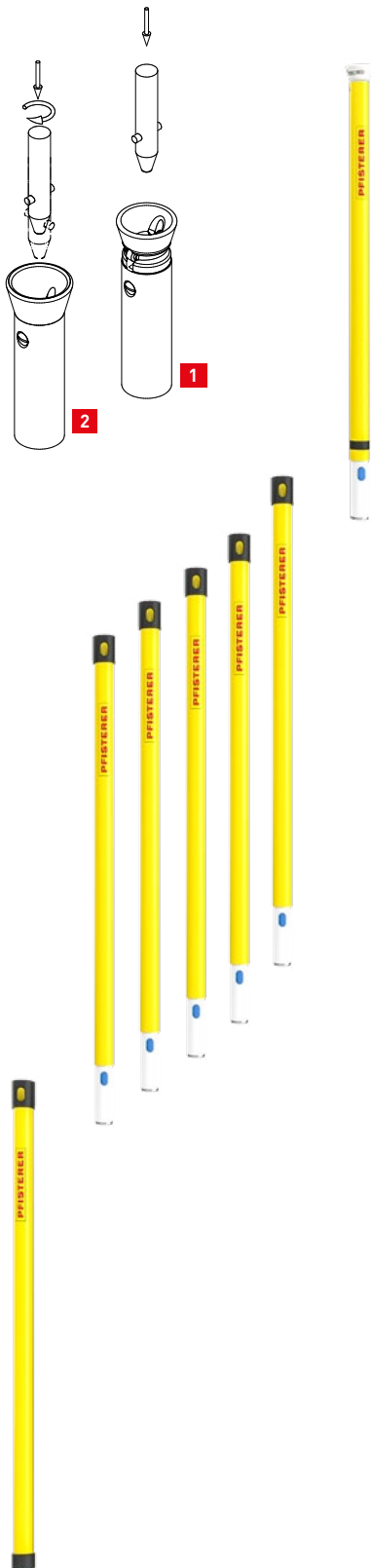

Earthing poles, plug-in

Plug-in earthing pole in different lengths with handle, a different number of extension sections, and an operating head, optionally with roller locking device or bayonet lock. Its short transportation length of 1.1 makes it easy to transport in cars.

Technical description

- Max. overall length of the operating pole: 7 m
- Max. length of individual element / transportation length: 1 m / 1.1 m
- Suitable for indoor and outdoor use
- Can be used in rain and snow
- Insulating poles made of glass-fibre reinforced polyester tube in yellow colour
- Individual configuration:
 - 1 earthing pole bottom section
 - Up to 5 extension elements
 - Earthing pole top section, with
 - Roller locking device, type D **1**
 - Bayonet locking device, type D **2**
- Optionally with storage bag (364 786 001) (max. 7 pole elements)

Max. overall length L_G (mm)	Handle	Number of extensions	Roller locking device type D	Bayonet locking device type D	Article no.
1995	•	–	•		364 172 002 / 00040
2950	•	1	•		364 172 002 / 00041
3905	•	2	•		364 172 002 / 00042
4860	•	3	•		364 172 002 / 00043
5815	•	4	•		364 172 002 / 00044
6770	•	5	•		364 172 002 / 00045
1995	•	–		•	364 172 002 / 00046
2950	•	1		•	364 172 002 / 00047
3905	•	2		•	364 172 002 / 00048
4860	•	3		•	364 172 002 / 00049
5815	•	4		•	364 172 002 / 00050
6770	•	5		•	364 172 002 / 00051

Operating heads with roller locking device type D (lockable) and bayonet locking device, type M (Scandinavia) available on request

3.1 Earthing poles

3

Two-piece earthing poles with line fixed point

The two-piece earthing pole with lowered aluminium line fixed point facilitates the attachment of earthing and short-circuiting devices to outdoor switchgear at great working heights.

It comprises an insulating lower pole section and an aluminium upper part with permanently attached line clamp and line fixed point. The aluminium upper section brings the line fixed point down to a working height of approx. 4.5 m above the ground.

Technical description

- Can be used for short-circuit currents up to 29.6 kA / 1 s (Cross-section of earthing and short-circuiting cable 150 mm²)
- Working heights up to 9 m possible (overall length plus 1 m handling height)
- Easy handling due to shorter earthing and short-circuiting cable
- Weight saving due to shorter earthing and short-circuiting cable
- Work site is visibly marked by the hanging earthing pole
- Lowered aluminium line fixed point
- Diameter of insulating pole: 43 mm

Two-piece earthing poles with line fixed point

Pole length L _G (mm)	Transportation length L _T (mm)	Line clamp	Article no.
4625	3135	P7	364 116 001 / 00017
5225	3135	P7	364 116 001 / 00018
5725	3135	P7	364 116 001 / 00019
6225	3135	P7	364 116 001 / 00020
6725	3625	P7	364 116 001 / 00021
7225	4125	P7	364 116 001 / 00022
7725	4625	P7	364 116 001 / 00023
8225	5125	P7	364 116 001 / 00024
4695	3135	P8	364 116 001 / 00025
5295	3135	P8	364 116 001 / 00026
5795	3135	P8	364 116 001 / 00027
6295	3135	P8	364 116 001 / 00028
6795	3625	P8	364 116 001 / 00029
7295	4125	P8	364 116 001 / 00030
7795	4625	P8	364 116 001 / 00031
8295	5125	P8	364 116 001 / 00032

For configuration example, see next page

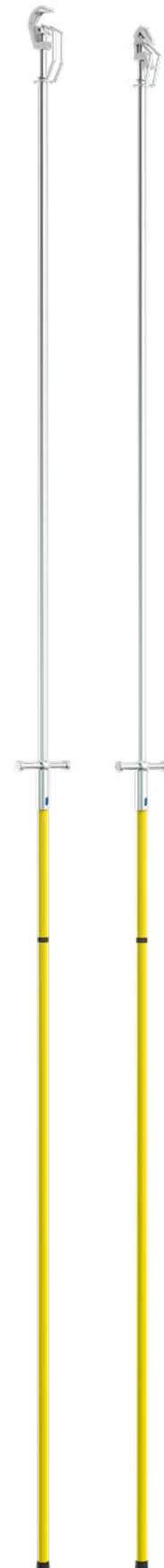

Application example



The two-piece earthing pole is hooked onto the line fixed point, tube or cable and tightened. It remains suspended during the entire earthing process. The line fixed point is brought down to a height of approx. 4.5 m above the ground.

The required overall length of the two-piece earthing pole results from the local working height less a handling height of approx. 1 m. At the line fixed point on the two-piece earthing pole, the single-pole earthing cable is attached by means of the P7D line clamp. The required height of the line fixed point at a height of 4.5 m can be easily reached with the telescopic operating pole (length 3 m plus handling height).

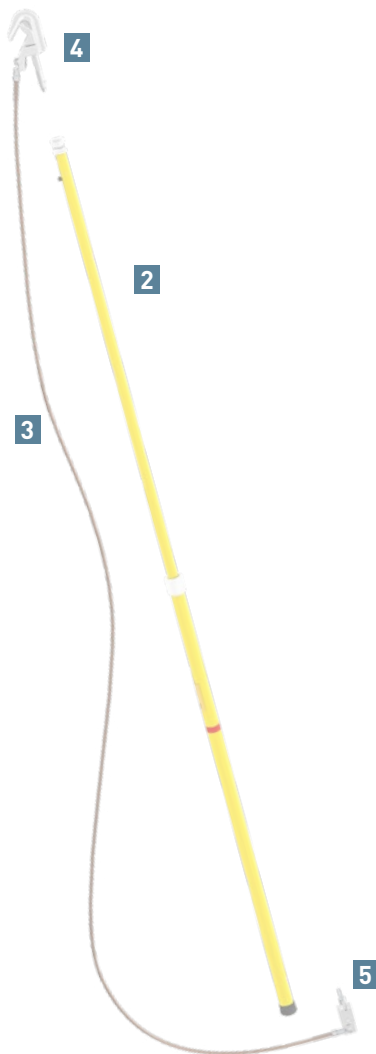

1 Two-piece earthing poles with line fixed point

For product details, see previous page

2 Earthing pole, telescopic (364 172 003 / 00125)

- Overall length: 2925 mm
- Transportation length: 1550 mm
- Operating head: Roller locking device

3 Single-pole earthing and short-circuiting cable (369 201 001 / 04455)

- Length of earthing cable: 5000 mm
- Cable cross-section: 150 mm²

4 Line clamp P7D (363 245 006)

5 Earthing clamp A2 (364 544 002)

- Clamping range: 16 - 22 mm

Operating pole sets 30 kV

The operating pole can be used as a switching pole or insulating pole to switch disconnectors or to insert insulating protective shutters. It is suitable for use in systems with rated voltages up to 30 kV. The 30 kV operating pole set can be individually configured from a total of nine individual elements, according to requirements.

Technical description

- Max. overall length of the operating pole: 5.02 m
- Max. length of individual element / transportation length: 1 m
- Suitable for indoor and outdoor use
- Can be used in rain and snow
- Insulating poles made of glass-fibre reinforced polyester tube in white colour
- Storage bag with pole compartments

Available individual parts

- Handle
- Insulating pole with hand protection disc and red ring
- Max. 3 extension elements
- Switching poles (2 variants)
- Operating heads
 - Roller locking device
 - Bayonet locking device
 - Universal head



Operating pole sets 30 kV

Max. overall length L_G (mm)	Handle	Insulating pole	Number of extensions	Operating head roller lock	Operating head bayonet lock	Switching head 900 mm	Switching head 500 mm	Universal head	Article no.
2320	•	•		•		•			364 172 008 / 00041
2320	•	•		•			•	•	364 172 008 / 00042
2750	•	•	1		•				364 172 008 / 00043
3220	•	•	1	•		•			364 172 008 / 00044
3220	•	•	1	•			•	•	364 172 008 / 00017
4120	•	•	2	•		•			364 172 008 / 00045
4120	•	•	2	•		•	•	•	364 172 008 / 00046
5020	•	•	3	•		•			364 172 008 / 00047
5020	•	•	3	•		•	•	•	364 172 008 / 00020

S33-HV

S33-IS

S33-IV

S33-AK

S33-AK-B

S33-SK

S33-SK

S33-UK



These insulating poles are suitable for use in **systems** with rated voltages **up to 110 kV**. They comprise a handle, hand protection disc, insulating section, limiting disc (red) and operating head.



Technical description

- Operating head with roller locking device
- Suitable for indoor and outdoor use (not in rain or snow)
- Red ring as a visible limit of the insertion depth
- Limiting disc as hand guard
- Insulating poles made of glass-fibre reinforced polyester tube in yellow colour

Insulating poles

Rated voltage U_N (kV)	Overall length L_G (mm)	Length of insulating section L_I (mm)	Handle length L_H (mm)	Article no.
30	1038	525	450	363 810 810
30	1538	525	605	363 810 811
30	2038	525	705	363 810 812
110	2038	1300	685	363 810 816
110	3038	1300	800	363 815 818

3 Operating poles

The telescopic insulating operating pole with branch saw is used for removing branches on or in the vicinity of live parts up to 36 kV.

Technical description

- Working height from 2.9 - 8.9 m
- Insulating poles of 1 m, 1.5 m or 2 m
- Safe insulation against live parts
- Robust branch saw with durable saw teeth
- Can be used in rain and snow



Operating poles

Overall length telescopic pole approx. (mm)	Insulating length L_i (mm)	Transportation length L_T (mm)	Overall length L_G (mm)	Article no.
2800	1500	1500	4900	364 172 006 / 00068
4300	1500	1845	6496	364 172 006 / 00072
5800	1500	2345	7996	364 172 006 / 00076
7300	1500	2845	9496	364 172 006 / 00080

Versions with different transportation/overall lengths and insulating pole lengths of 1.0 m and 2.0 m can be found in our online catalogue or are available on request.

The fuse tong is suitable for replacing high voltage fuses in switchgear.



Technical description

- 20° angled
- Rapid adjustment using the double-threaded spindle
- Inclined clamping jaws
- Mechanical overload coupling prevents the tong head from breaking
- Suitable for indoor and outdoor use (not in rain or snow)
- Designed and type-tested in accordance with DIN VDE V 0681 parts 1 and 3

Fuse tong

Rated voltage U_N (kV)	Immersion depth A_i (mm)	Overall length L_G (mm)	Transportation length L_T (mm)	Article no.
1 - 36	195	1250	1250	363 280 000

Bags and wall holders

Storage bags – type E

These storage bags are suitable for the secure transportation and dust-free storage of insulating poles.

- Hard-wearing imitation leather
- Velcro closure
- Shoulder strap

Length (mm)	Height (mm)	Type	Article no.
2200	180	E1	364 171 001
1200	180	E3	364 171 003
1800	180	E4	364 171 004
3100	180	E5	364 171 005
3700	180	E6	364 171 006



Storage bag – type F

These storage bags are suitable for the secure transportation and dust-free storage of up to five insulating poles.

- Hard-wearing imitation leather
- Velcro closure
- Shoulder strap

Length (mm)	Height (mm)	Type	Article no.
1140	500	F1	364 786 001



Wall holder for HH fuses

- Suitable for three HH fuses and one set of fuse tongs

For pole diameter (mm)	Width (mm)	Height (mm)	Depth (mm)	Article no.
43	30	530	150	364 007 001



Wall holders

- Suitable for earthing poles and operating poles

For pole diameter (mm)	Width (mm)	Height (mm)	Depth (mm)	Article no.
24	30	515	130	364 007 002
33	30	515	140	364 007 003
40 - 45	30	515	150	364 007 004



Flexible wall holders

Wall holders for holding and space-saving storage of voltage detectors, phase comparators and insulating poles.

- Holder made of impact-resistant plastic
- Retaining strap made of hard-wearing rubber
- Mount on guide rail 360 330 102 or directly on a wall



Pole diameter (mm)	Article no.
20 - 30	360 330 100
30 - 40	360 330 101

Guide rail for flexible wall holders

Aluminium guide rail for flexible wall holders 360 330 100 and 360 330 101



Length (mm)	Article no.
900	360 330 102

Fastening clips

Fastening clips for holding and space-saving storage of voltage detectors, phase comparators and insulating poles



Pole diameter (mm)	Article no.
21 - 24	360 330 110
25 - 29	360 330 111
29 - 33	360 330 112
34 - 38	360 330 113
39 - 43	360 330 114

Quiver

Quiver as support for pole diameters up to 38 mm



	Article no.
	360 330 115

Voltage detecting systems

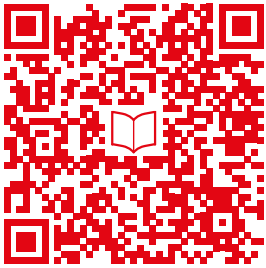

Voltage detecting systems in accordance with EN 61243-5:2001 are used to detect the absence of voltage on metal-enclosed switchgear and transformers. Since it is not possible for voltage detectors to come into contact with live parts of such systems, voltage detecting systems have to be used that unambiguously evaluate a capacitively coupled signal to indicate that operating voltage is present. The signal is provided via coupling electrodes, which may be integrated into capacitive insulators, transducers, bushings, Duresca bars as well as inner and outer cone cable connections.



High and low resistance systems

Voltage detecting systems are used in medium voltage and high voltage applications. The EN 61243-5:2001 standard makes a main distinction between two systems, which define the interface conditions for reliable operation:

- HR system (high resistance system)
- LRM system (low resistance system)

Extensive portfolio – ideal for CONNEX

PFISTERER's portfolio includes all the necessary components for both systems, such as connection materials, testing systems and phase comparators. Our voltage detecting systems are optimised for CONNEX connection technology components.

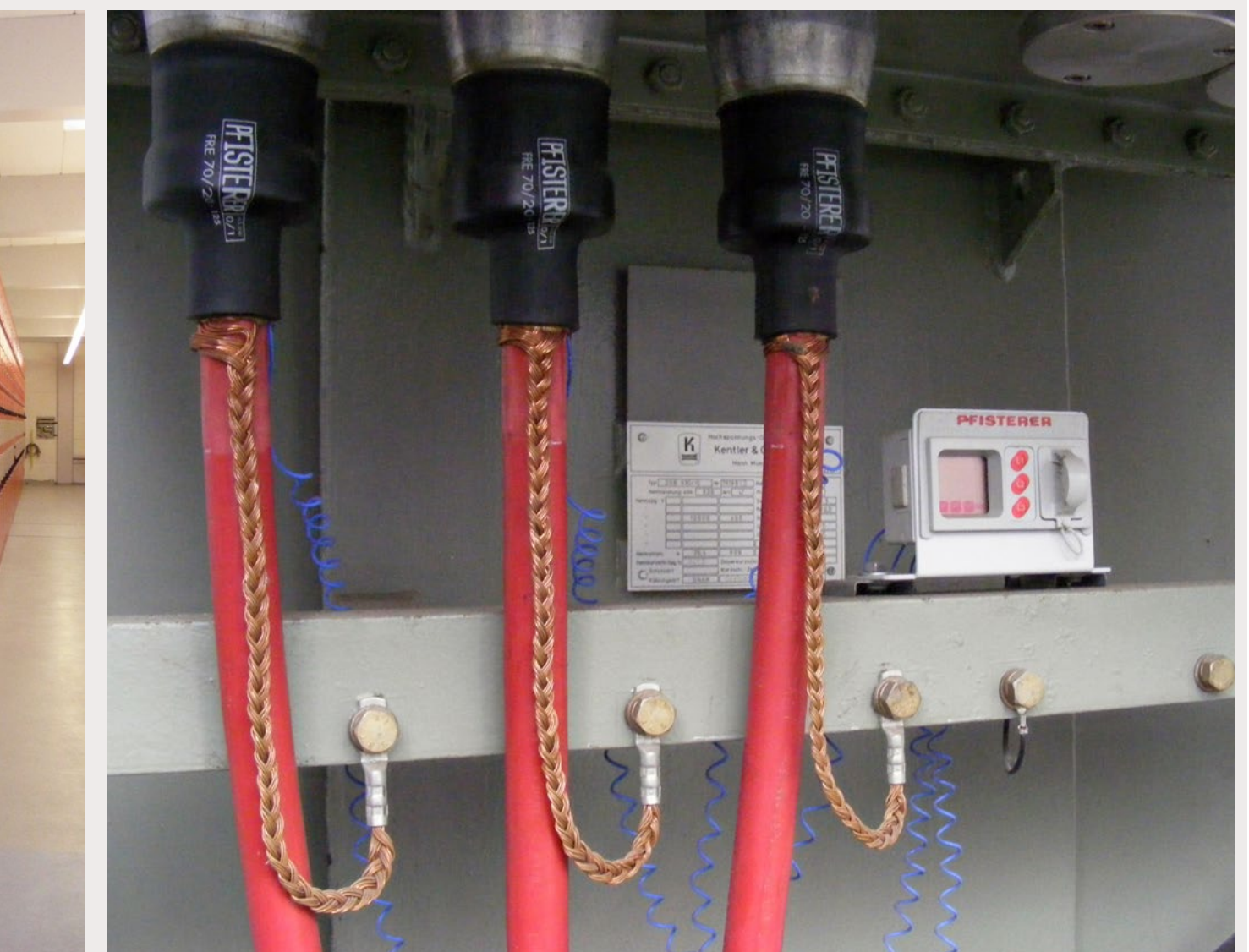

Continuous voltage indicator DSA-2

The DSA-2 continuous voltage indicator is a plug-in indicator for the HR system. It allows absence of voltage to be checked on the basis of capacitively sensed voltages.

Technical description

- No external power required
- Voltage indicated by flashing red LED
- Fully insulated system (IP66) made of impact-resistant plastic
- Moulded Euro plug
- Function test possible on 230 V AC power sockets
- In-service test possible with EURO-Test HR
- Suitable for all climate zones



Continuous voltage indicator DSA-2

	Article no.
	827 161 005

Continuous voltage indicator DSA-LRM

The DSA-LRM continuous voltage indicator is a plug-in indicator for the LRM system. It allows absence of voltage to be checked on the basis of capacitively sensed voltages.



Technical description

- No external power required
- Voltage indicated by flashing red LED
- Fully insulated system (IP66) made of impact-resistant plastic
- Integrated connector pins with seal to the interface
- In-service test possible with EURO-Test LRM
- Suitable for all climate zones

Continuous voltage indicator DSA-LRM

	Article no.
	827 020 001

4.2 Three-phase voltage detecting systems

Integrated voltage detecting system DSA-i3

The DSA-i3 integrated voltage detecting system with built-in display is designed for installation in switchgear cabinets. An additional indicator makes in-service tests unnecessary. This voltage detecting system is therefore maintenance-free, reliable and cost-effective in continuous operation.

For use with interface conditions in accordance with EN 61243-5 or EN 61271-213.

**Technical description**

- No external power supply required
- Red LCD display
- Test sockets for carrying out a phase comparison
- Additional third socket for checking the integrated LCD display
- Secure cover for sockets
- Conscious test process using three buttons
- Integrated voltage-limiting predetermined breaking point
- Simple installation
- No in-service tests required
- Interface adaptation possible by means of additional capacitances
- Protection class IP66
- Operating temperature -25 ... +55 °C
- Dimensions (mm): width 96 x height 48 x depth 30

Integrated voltage detecting systems DSA-i3

Additional capacitance C (nF)	Rated frequency f_N (Hz)	Threshold voltage (V)	Input impedance (M Ω)	Article no.
—	50	4 - 5	2	827 216 004 / 00058
0.47	50	4 - 5	2	827 216 004 / 00055
2.2	50	4 - 5	2	827 216 004 / 00059
3.3	50	4 - 5	2	827 216 004 / 00063
10	50	4 - 5	2	827 216 004 / 00060
33	50	4 - 5	2	827 216 004 / 00062
68	50	4 - 5	2	827 216 004 / 00067

Mounting bracket

This practical mounting bracket is available for mounting the DSA-i3 integrated voltage detecting system away from front panels.

Article no.
993 008 002



Interfaces and connecting leads



Three-pole interface for HR system

This three-pole interface for HR systems is designed as a measuring and testing block with safety test socket and earthing socket. It can be mounted on switchgear.

Article no.
560 915 001



Single-pole interface for HR system

This single-pole interface for HR systems is designed as a test socket. It can be mounted anywhere near the capacitive tap.

Article no.
827 668 001

According to the standard, the interface must also be designed with a voltage-limiting predetermined breaking point. This interface, the connections on the coupling element and the voltage-limiting predetermined breaking point must be protected separately against moisture.



4.3 Test devices for voltage detecting systems

4

Test devices for voltage detecting systems

These test devices can be used to carry out function tests on continuous voltage indicators. They can also be used for the in-service test. These test devices are operated on a power socket and, during the function test, simulate the minimum response thresholds specified in the standard.

EURO-Test HR

The EURO-Test HR tester is suitable for checking the continuous voltage indicator of HR systems.



Min. threshold voltage U_{\min} (V)	Min. threshold current range I_{\min} (μ A)	Permissible ambient temperature ($^{\circ}$ C)	Standby indicator	Article no.
90	2.5	-25 ... +55	LED	827 160 001

EURO-Test LRM

The EURO-Test LRM tester is suitable for checking the continuous voltage indicator of LRM systems.



Min. threshold voltage U_{\min} (V)	Min. threshold current range I_{\min} (μ A)	Permissible ambient temperature ($^{\circ}$ C)	Standby indicator	Article no.
5	2.5	-25 ... +55	LED	827 160 003

Testers for continuous voltage indicators and interfaces



MP-Test

The MP-Test tester is suitable for testing the interfaces on HR systems and LRM systems. It can be used in conjunction with a multimeter.

	Article no.
	827 094 001



Test kit

This test kit contains test devices for continuous voltage indicators and interfaces for the HR as well as the LRM system.

Technical description

- Practical storage case with foam insert
- Multimeter
- MP-Test
- EURO-Test HR
- EURO-Test LRM

	Article no.
	827 092 002



Data sheet for specifying earthing and short-circuiting devices

Request for earthing and short-circuiting device

Dear Customer,

Please complete the information below so that we can process your request as quickly as possible.

Company:	Your name:
Phone	Date:
Email:	Signature:

1

Earthing and short-circuiting device	Single-pole 369201001 <input type="checkbox"/>	Two-pole 369100001 <input type="checkbox"/>	Three-pole 369203001 <input type="checkbox"/>	Four-pole 369100003 <input type="checkbox"/>
Line clamp				
Earthing cable				
Earthing clamp				

2

Short-circuiting cable cross-section:	mm ²	Length of short-circuiting cable a:	mm
Earthing cable cross-section:	mm ²	Length of short-circuiting cable b:	mm
Line clamp:		Length of short-circuiting cable d:	mm
Earthing clamp:		Length of earthing cable c:	mm

3

Information about PFISTERER clamps can be obtained by phone, email, or via the online catalogue on our website.

Please send the completed data sheet to your local PFISTERER representative, or to info@pfisterer.com

PFISTERER Holding AG

Rosenstrasse 44
73650 Winterbach
Germany
Phone: +49 7181 7005 0
Fax: +49 7181 7005 565
info@pfisterer.com
www.pfisterer.com

Contact for safety equipment

ETS Engineering & Technical Sales Service

Phone: +49 7323 83 808
Email: T-TS-COMPONENTS@pfisterer.com

Maintenance inspection

Phone: +49 7323 83 634
Phone: +49 7323 83 815
Email: service-whp@pfisterer.com

PFISTERER Kontaktsysteme GmbH
Maintenance inspection department
Bahnhofstrasse 30
89547 Gerstetten-Gussenstadt
Germany

100
YEARS
PFISTERER
SINCE 1921

In 1921 Karl Pfisterer founded his factory for special electrical products in Stuttgart with the aim of improving the world of power transmission. The PFISTERER Group has pursued this goal of quality and technological leadership for more than 100 years. Today, PFISTERER is one of the world's leading specialists and system suppliers for energy infrastructure – with a complete range of cable fittings, overhead line technology and components along the entire transmission chain from power generation to consumption.

With state-of-the-art manufacturing processes and 1,200 employees at 18 international locations, PFISTERER not only connects the power grids of today and tomorrow, but also makes an important contribution to a sustainable and secure energy supply.